

## Datasheet

### Features

- CMOS Color LineScan Sensors:
  - 4096 pixels, 5x5µm
  - 2048, 1024 or 512 pixels, 10x10µm
- Interface : CameraLink® (Base or Medium)
- Line Rate :
  - Up to 40 kl/s for the Base Version
  - Up to 100 kl/s for the High-Speed Version
  - Data Rate : 40, 42.5, 60 and 85MHz
  - Bit Depth : 24 bits RGB
  - Flat Field Correction
  - Color Correction Matrix
  - Automatic White Balance
  - Power Supply : 10 – 15V. PoCI Compliant.
  - Low Power Consumption : < 3.5W
  - M42x1 Native and F-Mount, C-Mount adapters available
  - GenCP Compliant (xml file embedded)



### Description

e2v's UNiiQA+ line scan cameras family has been specifically designed to overcome the limitations of your current inspection system: make cost savings, improve your throughput, inspect larger areas or identify smaller defects. Three UNiiQA+ product ranges are offered:

- UNiiQA+ Essential: low speed cameras for cost effective equipment or with modest speed requirement
- UNiiQA+ High-Speed: high speed cameras to help improve the performance of your system

The UNiiQA+ family has also been designed to be highly modular to enable engineers to reuse the same camera in multiple equipment, simplify logistics and reduce development cycle time. All UNiiQA+ cameras feature e2v's proprietary CMOS sensors : a single line of highly sensitive pixels of either 5µm or 10µm size.

### Application

- On-line quality control
  - Raw material inspection (plastic film, glass, wood...)
  - Print and paper inspection
- Sorting
  - Food sorting (Belt sorting, Lane sorting, Free fall sorting)
  - Parcel and postal sorting
  - Barcode reading



## Key Specifications

Characteristics	Typical Value				Unit
<b>Sensor Characteristics at Maximum Pixel Rate</b>					
Resolution	4096	2048	1024	512	Pixels
pixel size (square)	5 x 5	10 x 10	10 x 10	10 x 10	µm
Max Line Rate (Essential Version)					
CameraLink Base (1 x RGB channel at 85MHz)	20	40	40	40	kHz
Max Line Rate (High Speed version)					
CameraLink® Base (1 x RGB channel at 85MHz)	20	40	80	80	kHz
CameraLink® Medium (2 x RGB channels at 85MHz)	40	80	100	100	kHz
<b>Radiometric Performance at Maximum Pixel Rate and minimum camera gain</b>					
Bit depth	24 RGB				Bits
Peak Response (B/G/R)	2.8 / 3.8 / 4.1				LSB <sub>8bits</sub> /(nJ/cm <sup>2</sup> )
Camera Gain	1.1 <sup>(*)</sup>				e-/LSB <sub>12bits</sub>
Full Well Capacity	23,7 <sup>(*)</sup>				Ke-
Response non linearity (Max)	1				%
Readout Noise	7,5 <sup>(*)</sup>				e-
Dynamic range	56				dB
SNR Max (3/4 Sat)	39.5				dB
PRNU HF Max	3				%

Note : All values in LSB are given in 8 bits format

Functionality (Programmable via Control Interface)		
Analog Gain	Up to 12 (x4)	dB
Offset	-4096 to +4096	LSB
Trigger Mode	Timed (Free run) and triggered (Ext Trig, Ext ITC) modes	
<b>Mechanical and Electrical Interface</b>		
Size (w x h x l)	60 x 60 x 33.65	mm
Weight	<150	g
Lens Mount	F, C and M42x1 (on the Front Face)	-
Sensor alignment ( see chapter 2.1 )	±100	µm
Sensor flatness	50	µm
Power supply	Single 10 DC to 15 DC	V
Power dissipation	< 3,6 (PoCL compliant)	W
<b>General Features</b>		
Operating temperature	0 to 50 (front face), 70 (internal)	°C
Relative Humidity for Operation	85%	%
Storage temperature	-40 to 70	°C
Regulatory	CE, FCC , Reach, RoHS and Chinese RoHs compliant	

- <sup>(\*)</sup> Values per ADC (per color)
- <sup>(\*\*)</sup> Blue/Green/Red in LSB<sub>8bits</sub>/(nJ/cm<sup>2</sup>)
- Figures in LSB are for a 8bits format.
- Measured at Max Exposure Time and Nominal Gain (No Gain)
- Maximum data rate
- Stabilized temperature 30/40/55 °C (Room/Front Face/Internal)
- SNR Calculated at 75% Saturation with minimum Gain.

## Image Sensor

The Uniiqa+ sensor is composed of two sensitive lines of 4096 pixels of 5µm square : One composed of Green pixels only, the second one composed alternatively of Red/Blue Pixels.

Each pixel on the same column uses its own Analog to Digital Column converter (ADC Column).

This structure allows several definitions :

- 4k pixels 5x5µm (Full Definition) :
- The 2 color lines are exposed with a delay of one line in order to match the same position between the green line and the red/blue line
- 2k Pixels 10x10µm (True Color) :
- The colored pixel is composed of 2x Green pixels, one red and one blue exposed in the same time.
- Then, 1k or 0,5k 10x10µm are achieved by applying an ROI on the centre of the sensor from the 2k 10x10µm

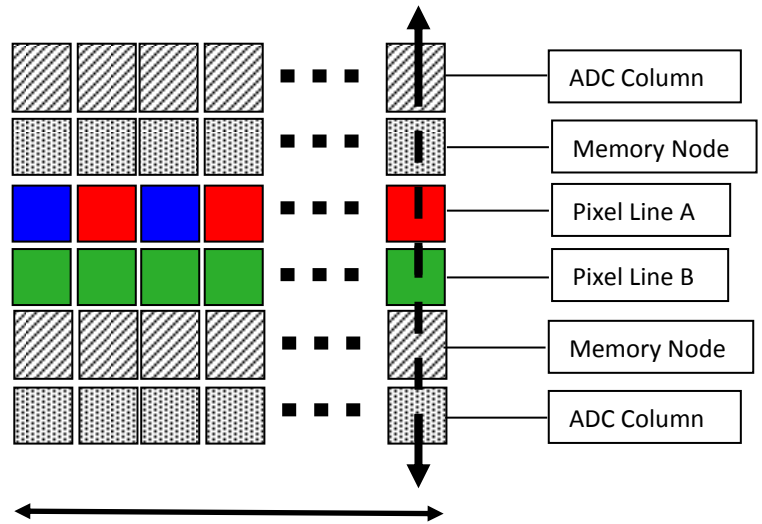

4096 Pixels 5x5µm

### 4k pixels 5x5µm (Full Definition)

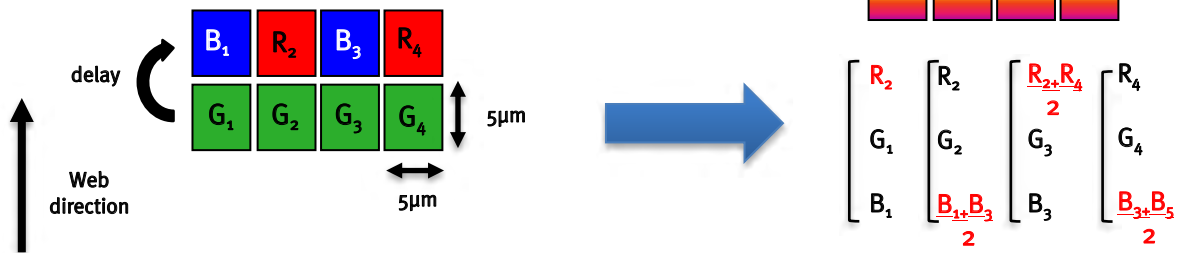

This color mode (5µm) requires the indication of "Forward/Reverse" to the camera in order to manage the delay between the two colored lines.

### 2k, 1k or 512 pixels 10x10µm (True Color)

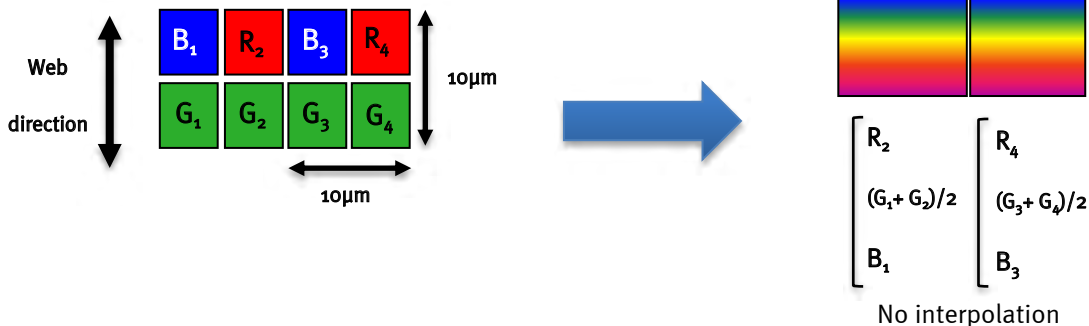

These color modes don't require any Reverse/Forward indication if no interpolation is used (or only the "column interpolation")

## Column Interpolation Correction (True Color only)

This interpolation is used to compensate the color error in the Red or the Blue in case of a vertical transition on the web : The Red of the blue value of each colored pixel is corrected if the variation between two neighbour green pixels is significant.

$B_1' = \alpha_B \times B_1$  and  $\alpha_B$  is the blue correction, calculated with the variation  $(G_1 - G_2)$

$R_2' = \alpha_R \times R_2$  and  $\alpha_R$  is the red correction, calculated with the variation  $(G_1 - G_2)$

- This interpolation is available for all pixel sizes : 5x5µm but also 10x10µm
- It can be disabled by the customer. By default, it is enabled.

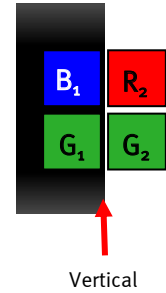

## Line Interpolation Correction (True Color only)

This interpolation is used to compensate the color error in the Red or the Blue in case of a horizontal transition on the web in the same "True Color" pixel : A line is memorized and the Red of the blue value of each colored pixel is corrected if the variation between two consecutive green values (previous to next line) is significant :

$B_1' = \alpha_B \times B_1$  and  $\alpha_B$  is the blue correction, calculated with the variation  $(G_1 - G'_1)$

$R_2' = \alpha_R \times R_2$  and  $\alpha_R$  is the red correction, calculated with the variation  $(G_2 - G'_2)$

- This interpolation is available only for pixel size 10x10µm (True Color)
- It can be enabled by the customer. By default, it is disabled
- This interpolation requires the Forward/Reverse indication sent to the camera for the memorized line.

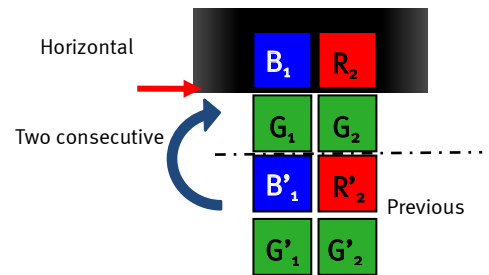

## Effects of the interpolations

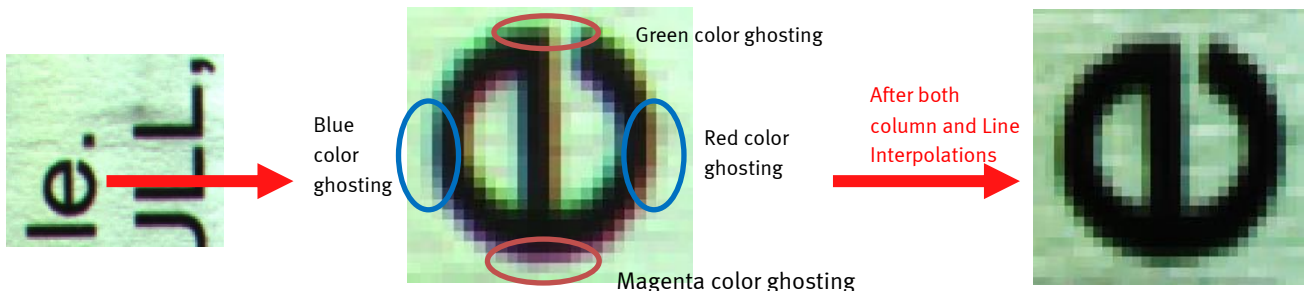

Horizontal transition effect reduced by the "Line Interpolation"



Vertical transition effect reduced by the "Column Interpolation"

## Response & QE curves

### Quantum Efficiency

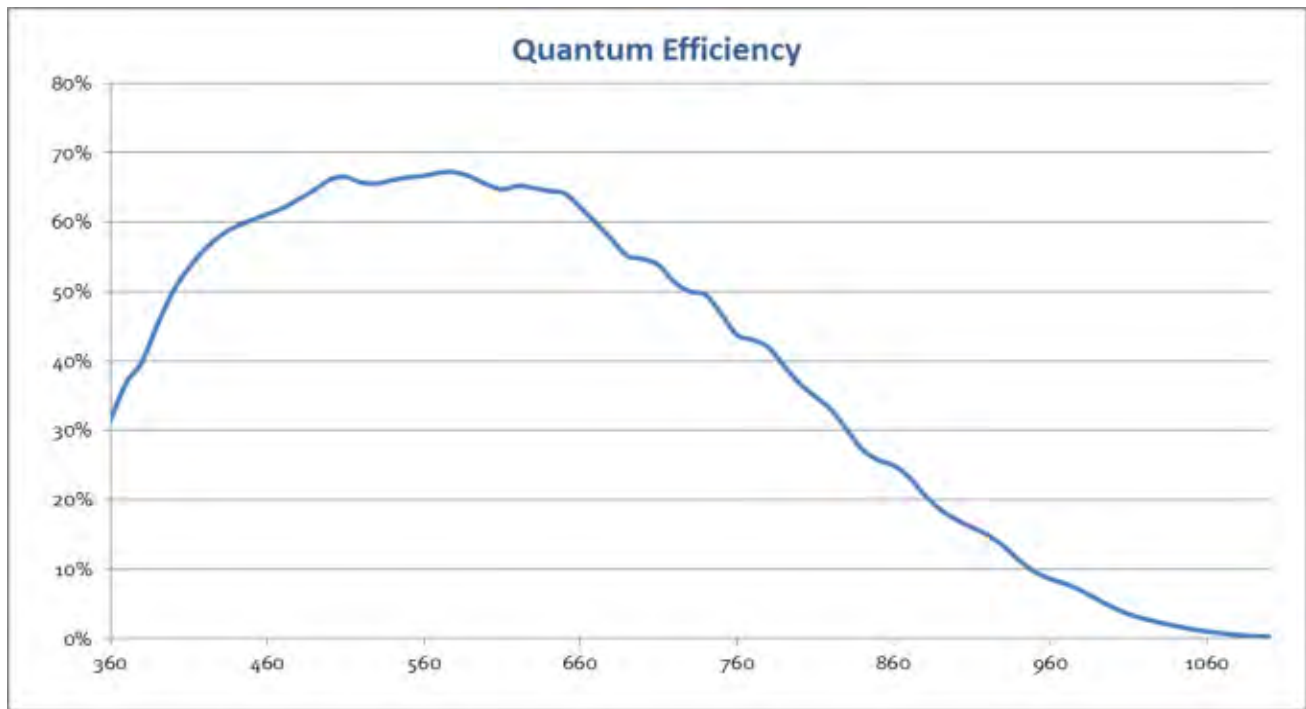

### Spectral Response Curve

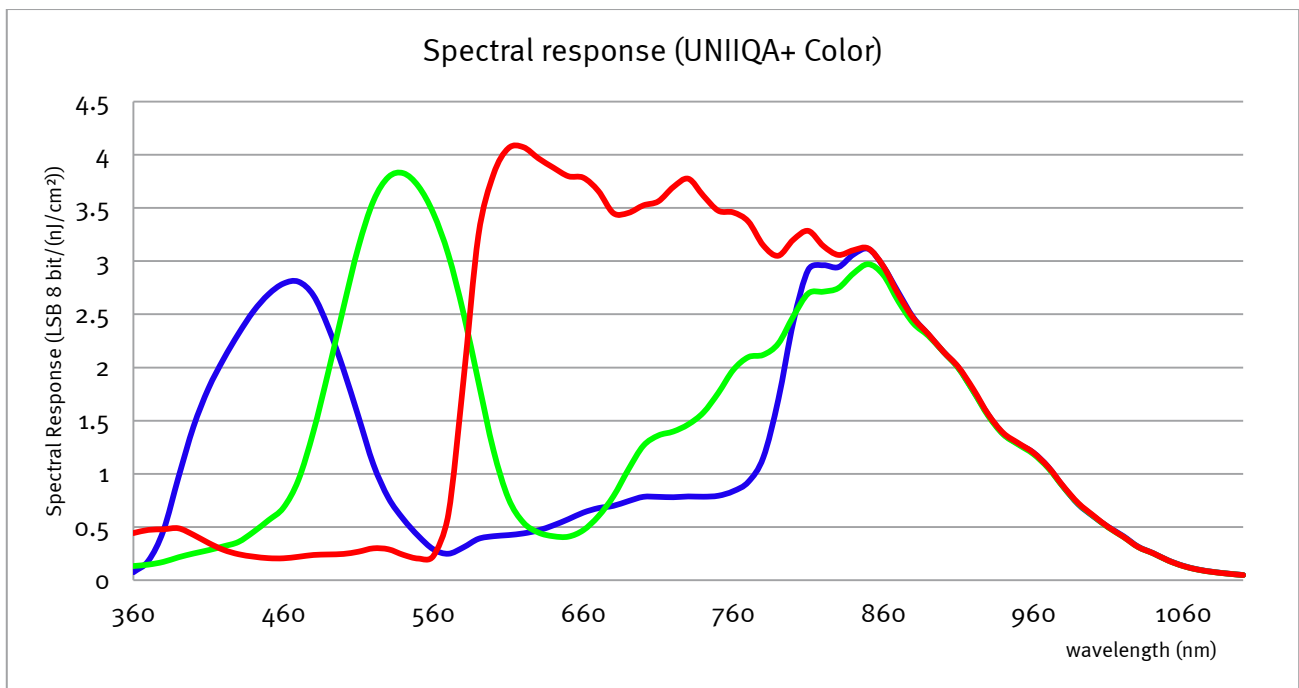

## Camera Hardware and Interface

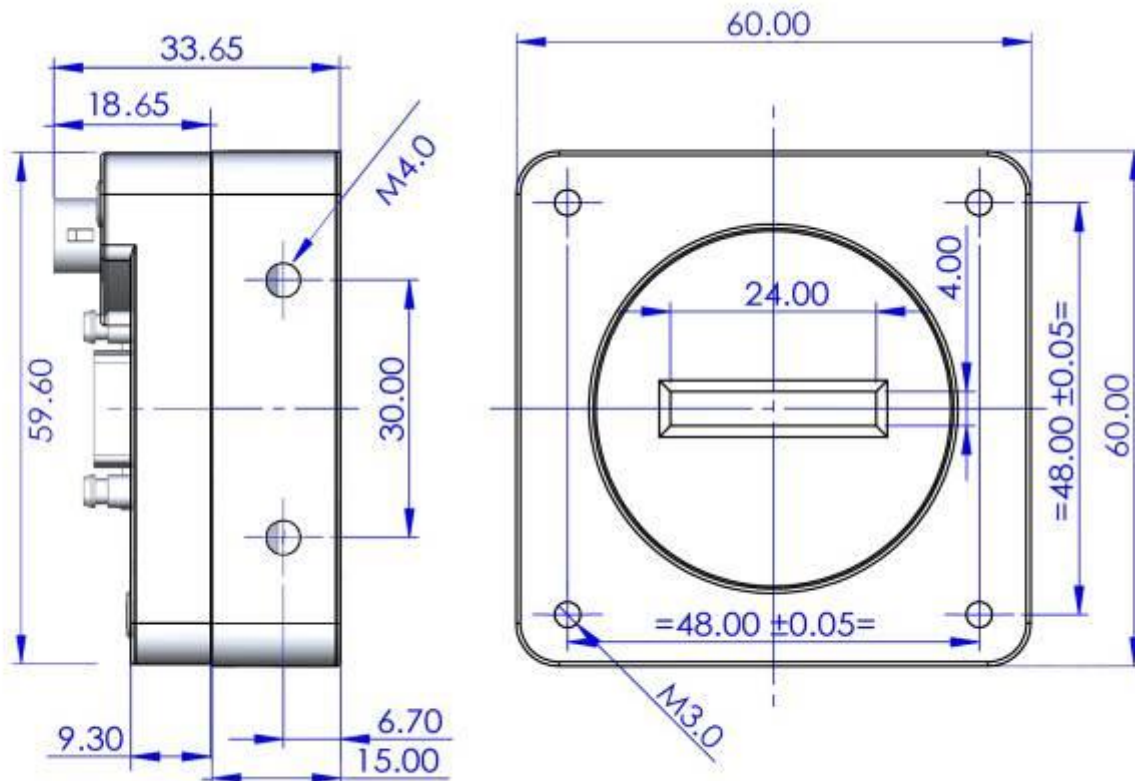

**Essential Model**

The Step file is available  
 on the web :  
[www.e2v.com/cameras](http://www.e2v.com/cameras)

**High Speed Model**

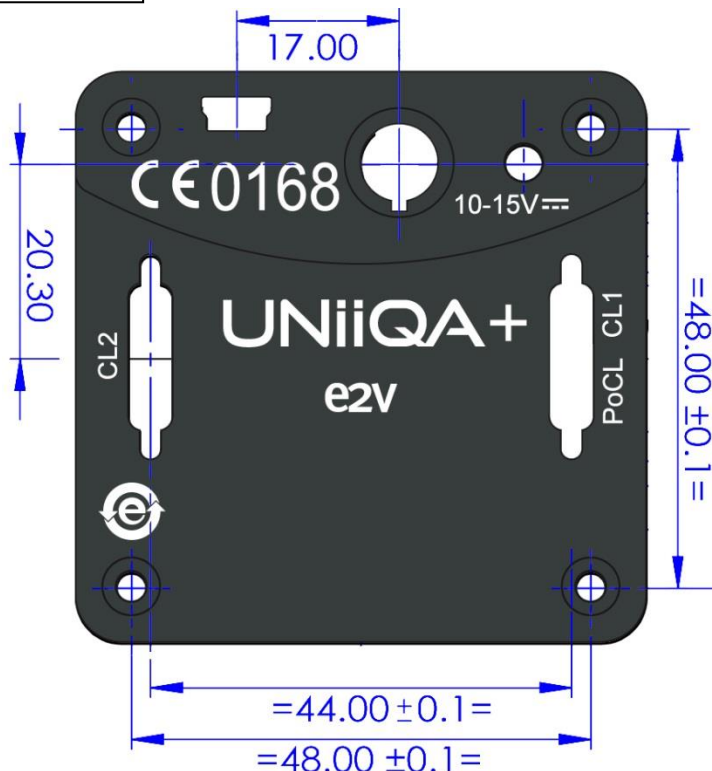
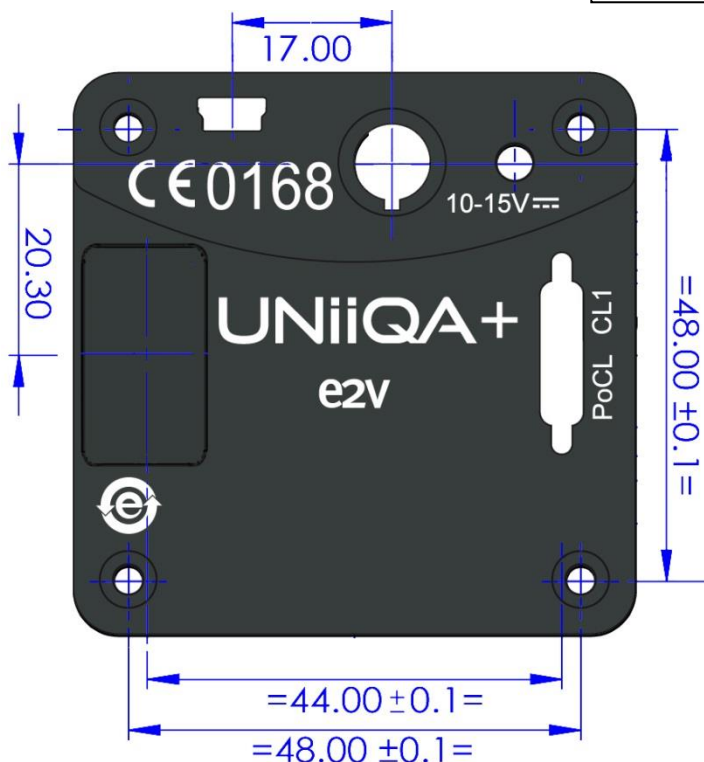



## Input/output Connectors and LED



## Power Connector

Camera connector type: Hirose HR10A-7R-6PB (male)

Cable connector type: Hirose HR10A-7P-6S (female)

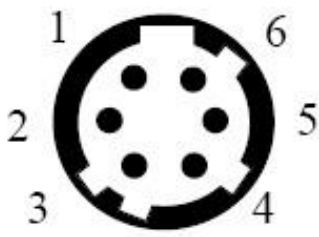
 <p>Camera side description</p>	Signal	Pin	Signal	Pin
	PWR	1	GND	4
	PWR	2	GND	5
	PWR	3	GND	6
Power supply from 10 to 15v Power 3,5W max with an typical inrush current peak of <b>0,32A</b> during power up				

## CameraLink Output Configuration

	Adjacent Channels	RGB Pixels per Channel			
<b>Version "Essential" and "High Speed"</b>		4k	2k	1k	0,5k
Base : 1 Channel 24 bits RGB	1 x 85MHz (60/42.5MHz)	1 x 4096	1 x 2048	1 x 1024	1 x 512
<b>Version "High Speed" only</b>					
Base : 2 Channels 24 bits RGB	2 x 85MHz (60/42.5MHz)	2 x 2048	2 x 1024	2 x 512	2 x 256

## Standard Conformity

The UNIIQA+ cameras have been tested using the following equipment:

- A shielded power supply cable
- A Camera Link data transfer cable ref. 1MD26-3560-00C-500 (3M), 1SF26-L120-00C-500 (3M)
- A linear AC-DC power supply

e2v recommends using the same configuration to ensure the compliance with the following standards.

## CE Conformity

The UNIIQA+ cameras comply with the requirements of the EMC (European) directive 2004/108/EC (EN 50081-2, EN 61000-6-2).

**CE 0168**

## FCC Conformity

The UNIIQA+ cameras further comply with Part 15 of the FCC rules, which states that: Operation is subject to the following two conditions:

- This device may not cause harmful interference, and
- This device must accept any interference received, including interference that may cause undesired operation

This equipment has been tested and found to comply with the limits for Class A digital device, pursuant to part 15 of the FCC rules. These limits are designed to provide reasonable protection against harmful interference when the equipment is operated in a commercial environment. This equipment generates, uses and can radiate radio frequency energy and, if not installed and used in accordance with the instruction manual, may cause harmful interference to radio communications. Operation of this equipment in a residential area is likely to cause harmful interference

**Warning:** Changes or modifications to this unit not expressly approved by the party responsible for compliance could void the user's authority to operate this equipment.

## RoHS / Chinese RoHS

RoHS per EU Directive 2011/65/EC and WEEE per EU Directive 2002/96/EC

China Electronic Industry Standard SJ/T11364-2006



## GenICam / GenCP

GenICam/GenCP XML Description File, Superset of the GenICam™ Standard Features Naming Convention specification

V1.5, Camera Link Serial Communication : GenICam™ Generic Control Protocol (Gen CP V1.0)





## Models

	Camera Part Number	Description	Details
<b>UNIIQA+ Essential</b>	EV71YC1CCL4005-BA2	Versatile Base CameraLink	4k pixels 5x5µm up to 20kHz 2k, 1k and 0,5k pixels 10x10µm up to 40kHz
	EV71YC1CCL4005-BA0	4k Pixels Base CameraLink	4k pixels 5x5µm up to 20kHz
	EV71YC1CCL2010-BA0	2k pixels Base CameraLink	2k pixels 10x10µm up to 40kHz
<b>UNIIQA+ High Speed</b>	EV71YC1CCL4005-BA3	Versatile Full CameraLink	4k pixels 5x5µm up to 40kHz 2k, 1k and 0,5k pixels 10x10µm up to 80kHz
	EV71YC1CCL4005-BA1	4k Pixels Full CameraLink	4k pixels 5x5µm up to 40kHz
	EV71YC1CCL2010-BA1	2k pixels Full CameraLink	2k pixels 10x10µm up to 80kHz