

▲ A5031M/CU815E

- 5Gbps bandwidth USB3.0 interface
- 128MB on-board frame buffer
- Support multiple image data formats
- Conform to CE, FCC, RoHS certifications
- Software trigger/Hardware trigger/Free run mode
- Conforms to USB 3.0 vision protocol and GenICam standard

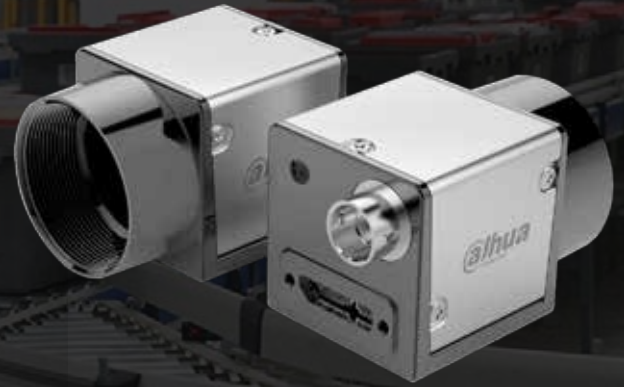

Specification

Model	Sensor	Sensor type	Shutter	Resolution	Frame rate (fps)	Bit depth	Interface	Mono/Color	Pixel size (μm)	Sensor size
A5031MU815E	PYTHON 300	CMOS	Global	640 x 480	815	10	USB3.0	Mono	4.8 x 4.8	1/4"
A5031CU815E	PYTHON 300	CMOS	Global	640 x 480	815	10	USB3.0	Color	4.8 x 4.8	1/4"

Model	A5031MU815E	A5031CU815E
Effective Pixels	0.3MP	
SNR	>38dB	
Dynamic Range	60dB	
GPIO	6 pin Hirose: 1 Opto-isolated input, 1 Opto-isolated output, 1 configurable input/output without opto isolation	
Image Format	Mono8/10/10Packed	BayerRG8, BayerGB8
Binning	Support	--
Gain	X1~X32	
Gamma	Range from 0 to 4, support LUT	
Exposure Time	1μs~1S	
Trigger Mode	Software trigger/Hardware trigger/Free run mode	
Image Buffer	64MB	
User Setting	Support two sets of user-defined configurations	
Dimensions	29mmx29mmx29mm(not including lens mount and rear case connector)	
Weight	60g	
Power Supply	Power supply via USB connector /DC power supply by Hirose connector, with voltage range from 6V to 26V	
Power Consumption	≈3.4W	
Lens Mount	C	
Temperature	Storage temperature:-30° C~ + 80° C; Operation temperature:-30° C~+50° C	

Spectrogram

A5031CU815E

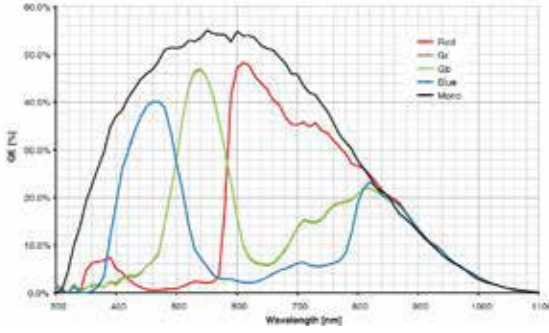

Quantum Efficiency Curve for Mono and Color Sensor

A5031MU815E

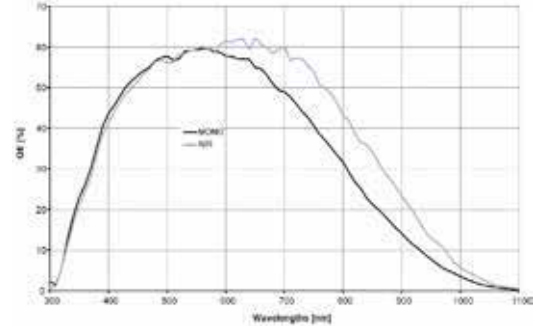

Quantum Efficiency Curve for Mono Sensor

Dimensions

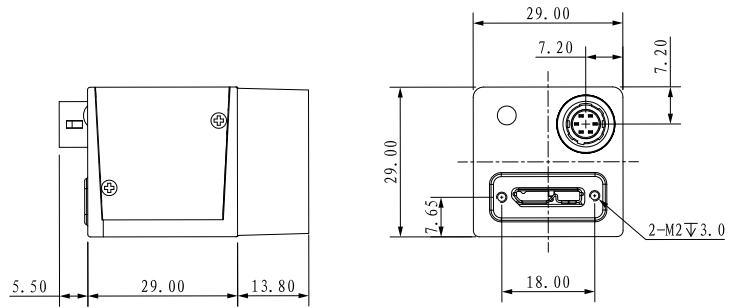
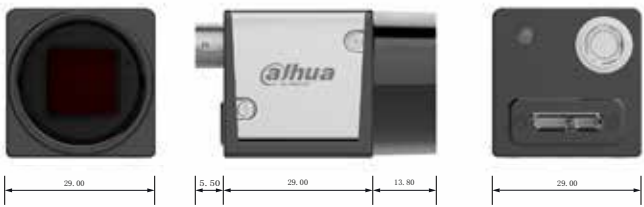

IO Interface Instruction

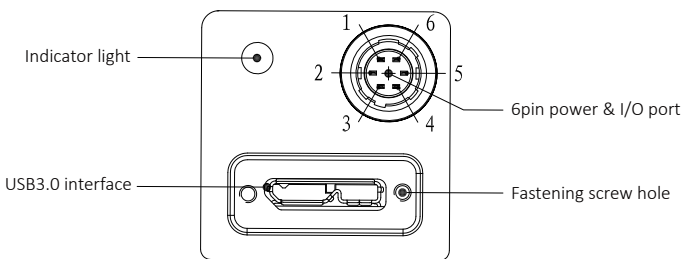

Pin	Signal	Description
1	Line3	DC 6V-26V input
2	Line1	Opto-isolated input
3	Line2	Configurable IO input/output
4	Line0	Opto-isolated output
5	IO GND	Opto-isolated ground
6	GND	Ground