



Genie™ Nano-CL Cameras

Smaller, faster, stronger, cheaper.

Compact Camera Link cameras with unprecedented speed and uncompromised image quality.

Introducing Genie Nano-CL, a Camera Link CMOS area scan camera that redefines **low cost** performance. Genie Nano-CL starts with industry leading image CMOS sensors from 5.1 to 25 megapixel resolution and adds proven Camera Link technology for **breakthrough speed**, a robust build quality for wide operating temperature, and an unmatched feature set—all at an **incredible price**.



Key Features

- Industry's latest CMOS image sensors
- Simplified set-up with field proven Sapera LT software featuring CamExpert
- Engineered to accommodate industrial environment with a ruggedized screw mount SDR connectors
- GenICam GenCP compliant

Programmability

- Higher frame rates achievable in partial scan mode
- Global electronic shutter with exposure control
- Multi-ROI feature

Reliability

- Robust all-metal body
- 3 year warranty
- Trigger to Image Reliability (T2IR) framework improves the reliability of your inspection system and protects you from data loss

Typical Applications

- Semiconductor wafer inspection
 - Surface and bump inspection
- Electronics manufacturing
 - 3D solder paste inspection
 - Package and bump inspection
 - Automated Optical Inspection (AOI)
- Solar panel inspection
- Aerial Imaging
- General machine vision

Regulatory Compliance

- CE, FCC, RoHS, GenICam, IP30, Camera Link 2.01

GENIE NANO-CL INDIVIDUAL MODEL SPECIFICATIONS

CAMERALINK (DECA MODE) 10-TAPS CONFIGURATION

	Active Resolution	Sensor Model	Frame Rate**	Pixel Size	Dynamic Range	Max. Image Circle	Data Format	Part Number
●●● CL-M2450	2448 x 2048	Sony IMX250 (5.1M)	141 fps	3.45 μm	56.4 dB	2/3" Optical Format	8 or 10-Bit Mono	G3-CM30-M2450
●●● CL-C2450	2448 x 2048	Sony IMX250 (5.1M)	141 fps	3.45 μm	56.4 dB	2/3" Optical Format	8 or 10-Bit Bayer	G3-CC30-C2450, G3-CC30-C2450IF (with IR cut-off filter)
●●● CL-M4060	4112 x 2176	Sony IMX255 (8.9M)	88 fps	3.45 μm	56.4 dB	1" Optical Format	8 or 10-Bit Mono	G3-CM30-M4060
●●● CL-C4060	4112 x 2176	Sony IMX255 (8.9M)	88 fps	3.45 μm	56.4 dB	1" Optical Format	8 or 10-Bit Bayer	G3-CC30-C4060, G3-CC30-C4060IF (with IR cut-off filter)
●●● CL-M4040	4112 x 3012	Sony IMX253 (12M)	64 fps	3.45 μm	56.4 dB	1.1" Optical Format	8 or 10-Bit Mono	G3-CM30-M4040
●●● CL-C4040	4112 x 3012	Sony IMX253 (12M)	64 fps	3.45 μm	56.4 dB	1.1" Optical Format	8 or 10-Bit Bayer	G3-CC30-C4040, G3-CC30-C4040IF (with IR cut-off filter)
●●● CL-M4160	4128 x 4128	Teledyne e2v Emerald EV2S16M (16M)	47 fps	2.8 μm	55 dB	1.1" Optical Format	8-Bit Mono	G3-CM30-M4160
●●● CL-C4160	4128 x 4128	Teledyne e2v Emerald EV2S16M (16M)	47 fps	2.8 μm	55 dB	1.1" Optical Format	8-Bit Mono	G3-CC30-C4160
●●● CL-M4090	4096 x 4096	On-Semi Python 16K (16M)	45 fps	4.5 μm	55.2 dB	APS-H Optical Format	8 or 10-Bit Mono	G3-CM10-M4095
●●● CL-M4090-NIR	4096 x 4096	On-Semi Python 16K (16M)	45 fps	4.5 μm	55.2 dB	APS-H Optical Format	8 or 10-Bit Mono	G3-CM12-M4095
●●● CL-C4090	4096 x 4096	On-Semi Python 16K (16M)	45 fps	4.5 μm	55.2 dB	APS-H Optical Format	8 or 10-Bit Bayer	G3-CC10-C4095
●●● CL-M5100	5120 x 5120	On-Semi Python 25K (25M)	30 fps	4.5 μm	55.2 dB	APS-H Optical Format	8 or 10-Bit Mono	G3-CM10-M5105
●●● CL-M5100-NIR	5120 x 5120	On-Semi Python 25K (25M)	30 fps	4.5 μm	55.2 dB	APS-H Optical Format	8 or 10-Bit Mono	G3-CM12-M5105
●●● CL-C5100	5120 x 5120	On-Semi Python 25K (25M)	30 fps	4.5 μm	55.2 dB	APS-H Optical Format	8 or 10-Bit Bayer	G3-CC10-C5105

** Using 10-tap @ 8-bit configuration. Applicable for the Deca model models list only.

CAMERALINK BASE CONFIGURATION

	Active Resolution	Sensor Model	Frame Rate***	Pixel Size	Dynamic Range	Max. Image Circle	Data Format	Part Number
●●● CL-M2420	2448 x 2048	Sony IMX264 (5.1M)	35 fps	3.45 μm	56.4 dB	2/3" Optical Format	8 or 12-Bit Mono	G3-CM31-M2420
●●● CL-C2420	2448 x 2048	Sony IMX264 (5.1M)	35 fps	3.45 μm	56.4 dB	2/3" Optical Format	8 or 12-Bit Bayer	G3-CC31-C2420, G3-CC31-C2420IF (With IR cut-off filter)
●●● CL-M4020	4112 x 3008	Sony IMX304 (12M)	20 fps	3.45 μm	56.4 dB	1.1" Optical Format	8 or 12-Bit Mono	G3-CM31-M4020
●●● CL-C4020	4112 x 3008	Sony IMX304 (12M)	20 fps	3.45 μm	56.4 dB	1.1" Optical Format	8 or 12-Bit Bayer	G3-CC31-C4020, G3-CC31-C4020IF (With IR cut-off filter)

*** Using 3-tap @ 8-bit configuration. Applicable for the Base CL model models list only.

GENIE NANO-CL FAMILY SPECIFICATIONS (COMMON TO ALL MODELS)

GENIE NANO CL (Medium Casing)		GENIE NANO CL (XL Casing)
Data Output Transfer	CameraLink (Deca Mode) 10-taps or (Base) 2 / 3-taps @ 85 Mhz configuration (model depended)	
Exposure Control	Automatic, programmable, or via external trigger	
I/O Ports	2 opto-isolated inputs, 2 opto-isolated ouputs, 2 Camera Link CC lines (Camera Control)	2 Camera Link CC lines (Camera Control)
Lens Mount	C-Mount available	M42
Size (L x H x W) (C-mount option)	44 mm x 44 mm x 21 mm (without bar adapter and connectors) 44 mm x 44 mm x 39 mm (with lens adapter and connectors)	30 mm x 59 mm x 59 mm (no lens adapter or connectors)
Mass	~72 g	~163 g
Operating Temp	-20 to +60° C (housing temperature)	
Power Supply	+10 to +30 V or Power Camera Link (PoCL)	
Power Dissipation (model dependent)	6.5 W @ 24 Volt Aux.	6.5 W @ 24 Volt Aux.
Data Connector	For CameraLink Deca mode	
Power and I/O Connector	SAMTEC TFM-105 type	
Camera Specification	Camera Link v2.1, GeniCam GenCP compliant	
Software Platform	Teledyne DALSA Sapera LT 8.0 for Windows, or 3rd Party GeniCam GenCP compliant SDK	



RESPONSIVITY GRAPHS

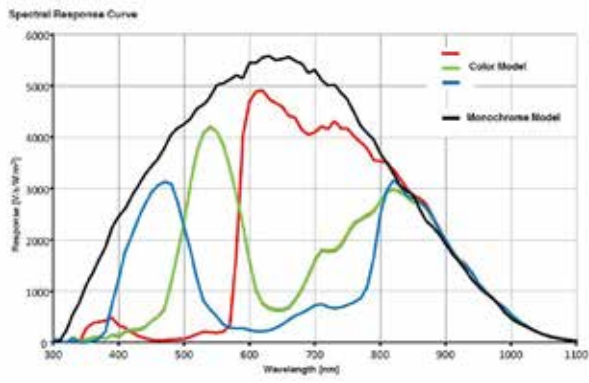

C4090 C5100

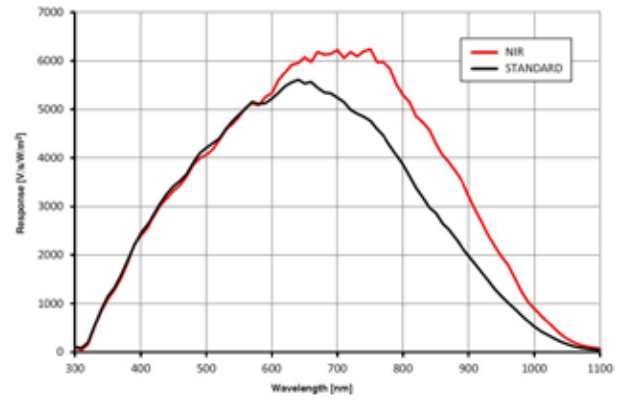

M4090 M5100

Spectral Sensitivity Characteristics

(Excludes lens characteristics and light source characteristics.)

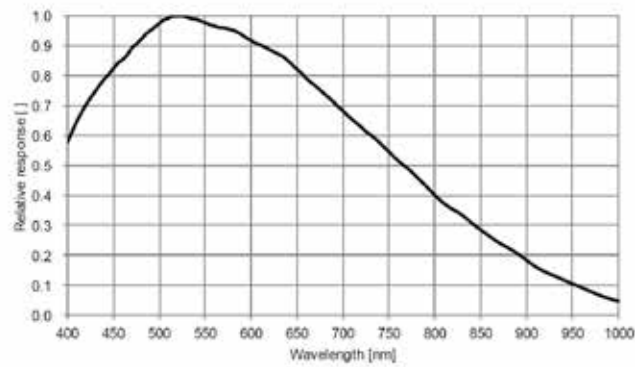

M4060 M4040 M2450 M4020 M2420

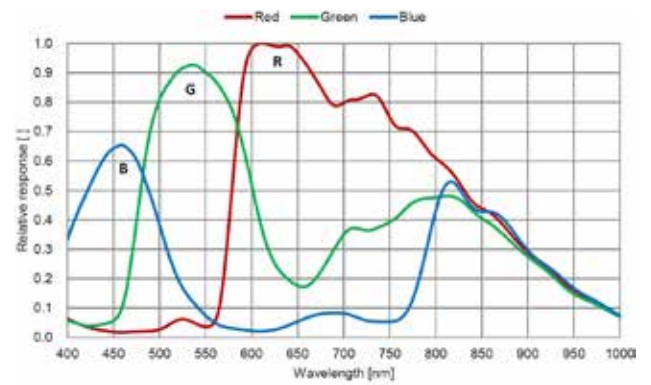

C4060 C4040 C2450 C4020 C2420



RESPONSIVITY GRAPHS



EV2S12M-16M Quantum Efficiency for mono version

M4160

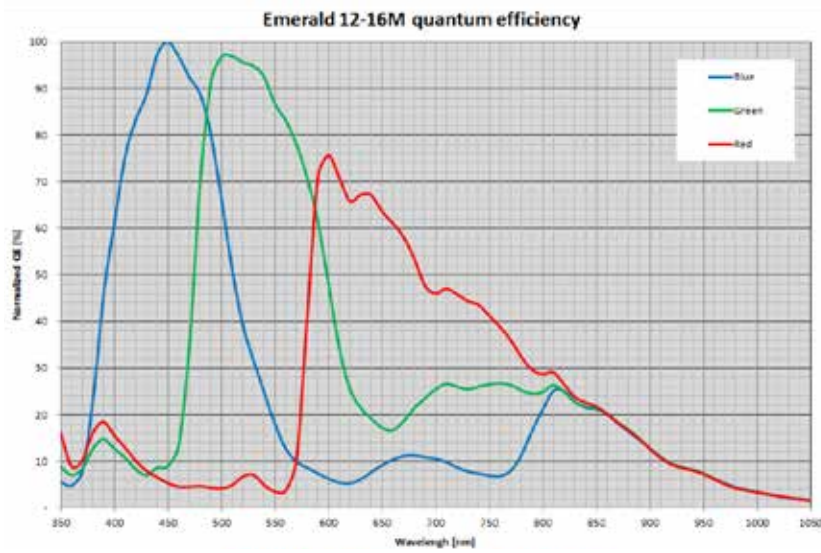

EV2S12M-16M Quantum Efficiency for color version

C4160

Genie™ Nano-CL Specifications

For Model 5.1M to 12M only

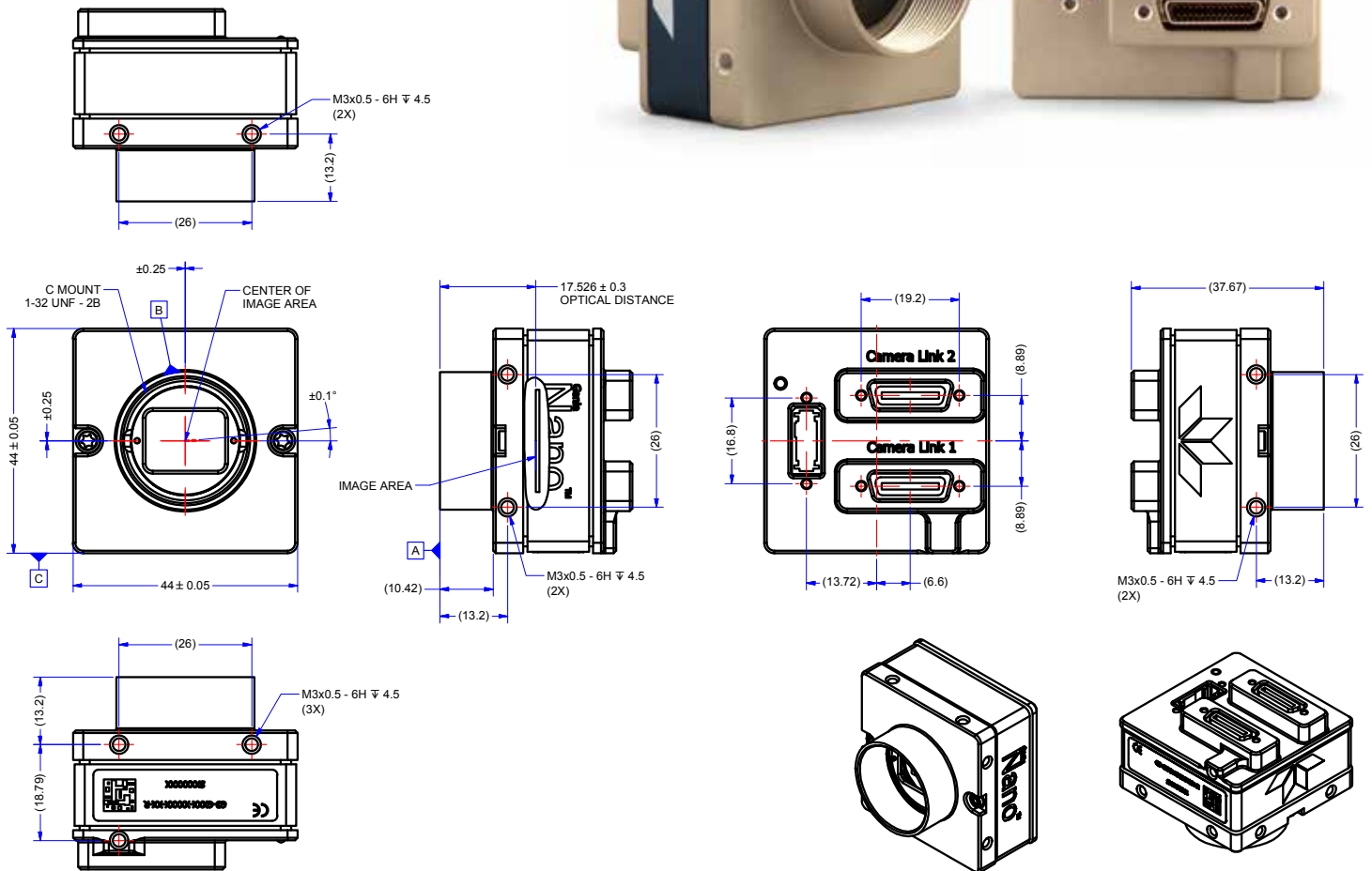

NOTES:
 1. UNITS: MILLIMETERS.
 2. IMAGE AREA IS ALIGNED TO DATUMS **A**, **B** & **C**.

Genie™ Nano-CL XL Specifications

For Model 16M to 25M only

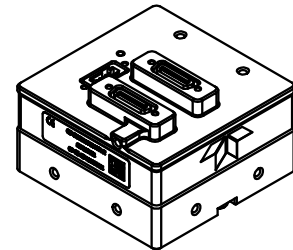
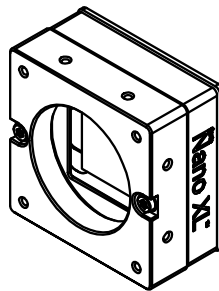
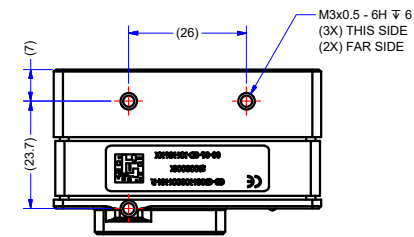
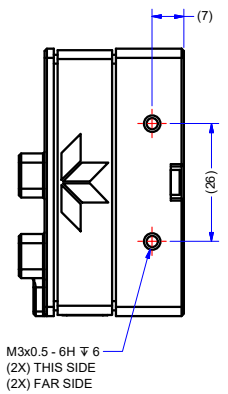
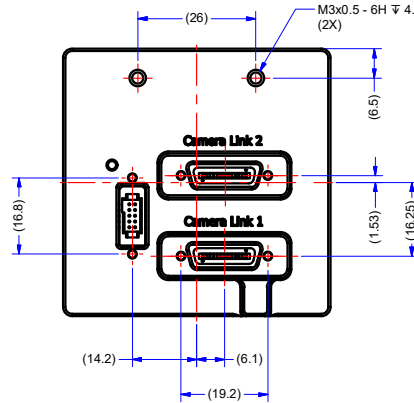
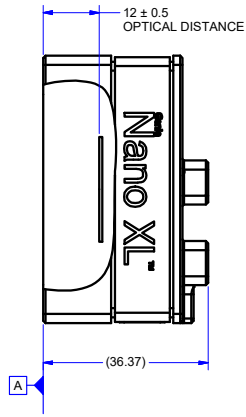
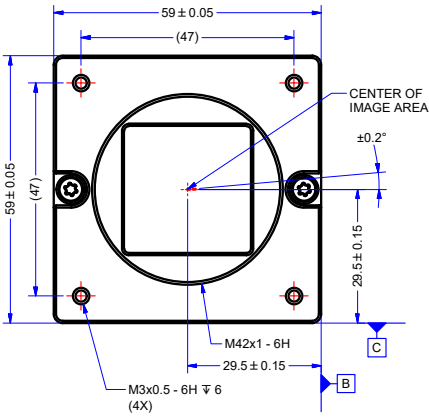
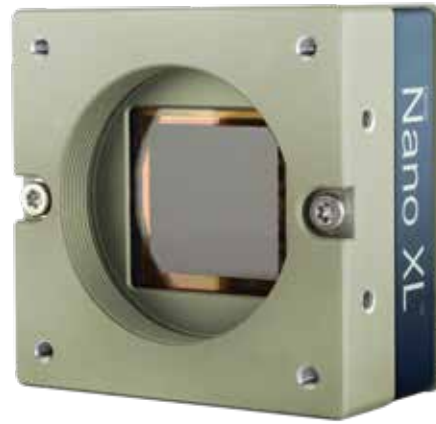

NOTES:
 1. UNITS: MILLIMETERS.
 2. IMAGE AREA IS ALIGNED TO DATUMS **A**, **B** & **C**.



Versatile camera series featuring Pregius® and Python® sensors