

Overdrive specifications Strobe Control Unit Enables even brighter emission of Light Units

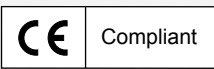

The supplied AC cord is for use with 100 to 120 VAC. If you want to use the Control Unit with 200 to 240 VAC, you must procure another appropriate AC power cord.

The PTU2 series enables strobe lighting with overdrive. Overdrive refers to brighter than normal emission of light by increasing the voltage and current supplied to the Light Unit.

Features

- The PTU2 series enables the lights to emit several times brighter than using the ON/OFF control function of the conventional PSB and PD3/PD2 series, or by strobe lighting using STU-3000.
- The two independent channels allow for setting each channel to emit for 10 to 990 μ s.

Example connections

Refer to the "Instruction Guide" for details.

(1) Non-voltage contact drive 1
(using drive-side power supply)

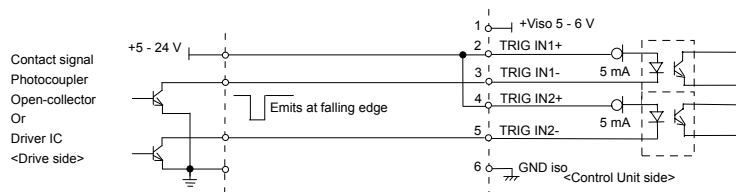

(2) Non-voltage contact drive 2
(using insulation power supply)

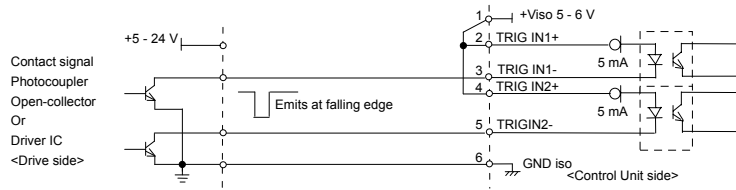

(3) If driven by the high-pulse voltage output signal

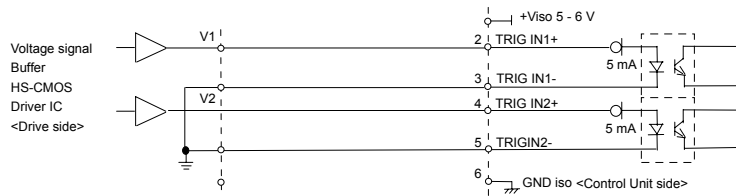

(4) External intensity input

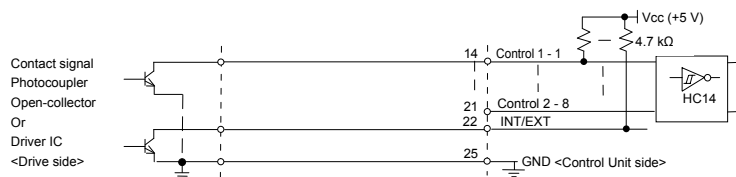

Low: 0 V or more 1.13 V max. High: 3.15 V or more 5 V max.

Overcurrent protection function

PTU2 Control Units forcibly stop the power output when the current consumption in the Light Unit exceeds the value shown below. The error lamp (red) on the front of the unit also flashes. Stopping of output is not released until the Control Unit is restarted.

Model name	PTU2-3012(A)	PTU2-3024(A)
Power consumption	8.5 A peak min	6.0 A peak min

Use 24 VDC and 20 mA max. for the OCP OUT load in order to obtain a margin.

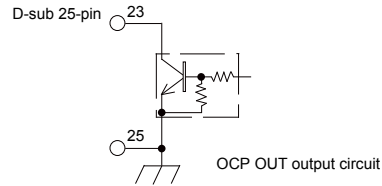

Example system configuration

Example:

External control device — External control cable — Control Unit — Extension cables — LED Light

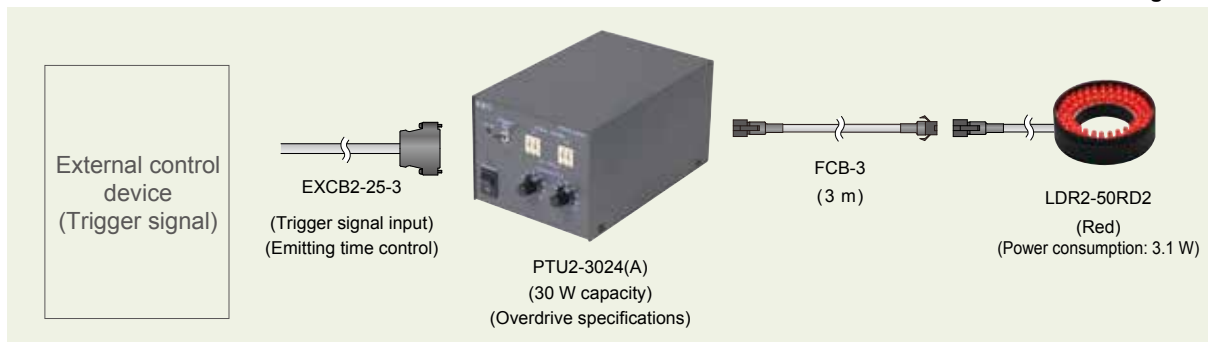

Specifications

Model name	PTU2-3012(A)	PTU2-3024(A)
Input voltage (rated)	100 to 240 VAC	
Frequency	50/60 Hz	
Inrush current (typ.)	15 A (for 100 VAC) 30 A (for 240 VAC) at cold start	
Output	18 VDC 8.1 A max. (Peak value when connected to max. load)	48 VDC 4.3 A max. (Peak value when connected to max. load)
Applicable Light Unit (rated)	Total for 2 channels: 27 W max.	
Lighting time	10 to 990 μ s Lighting time = Pulse Width [x10 μ s] x Control (10 to 100%) Pulse Width: 0 to 99 x 10 μ s Control: 10 to 100% (10% steps)	
Lighting delay	15 μ s max.	
Output connector	SMP-02V-BC	SMP-03V-BC
External control connector	D-sub 25-pin (plug), M2.6 screw	
Overcurrent protection	Output shutdown: 120% min. of rated load Reset by clearing the cause, and then turning the power off and on again.	
Weight	1.2 kg max.	
Accessories	3-prong AC cord with ground terminal (2 m) x 1, external control connector x 1, Instruction Guide x 1	

Dimensions (mm)

PTU2-3012(A)/3024(A)

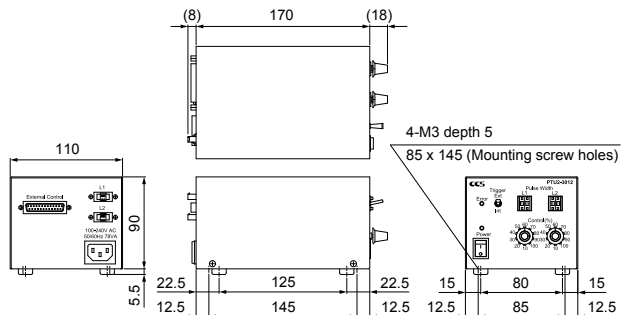

Options

External control cable

EXCB2-25-3 (3 m): D-sub 25-pin

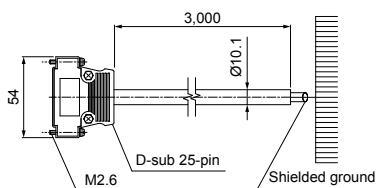

No.	Line color	No.	Line color	No.	Line color	No.	Line color
1	Black	9	Gray	17	Purple/Black	25	Brown/White
2	White	10	Pink	18	Grey/Black	NC	(Blue/White)
3	Red	11	White/Black	19	Pink/Black	NC	(Purple/White)
4	Green	12	Red/Black	20	Light green/Black	NC	(Grey/White)
5	Yellow	13	Green/Black	21	Black/White	NC	(Pink/White)
6	Brown	14	Yellow/Black	22	Red/White	NC	(Light green/White)
7	Blue	15	Brown/Black	23	Green/White		
8	Purple	16	Blue/Black	24	Yellow/White		

Dimensions (mm)