

# LED Light Units for Line Scan LND2 Series

Highly Uniform Diffused Light

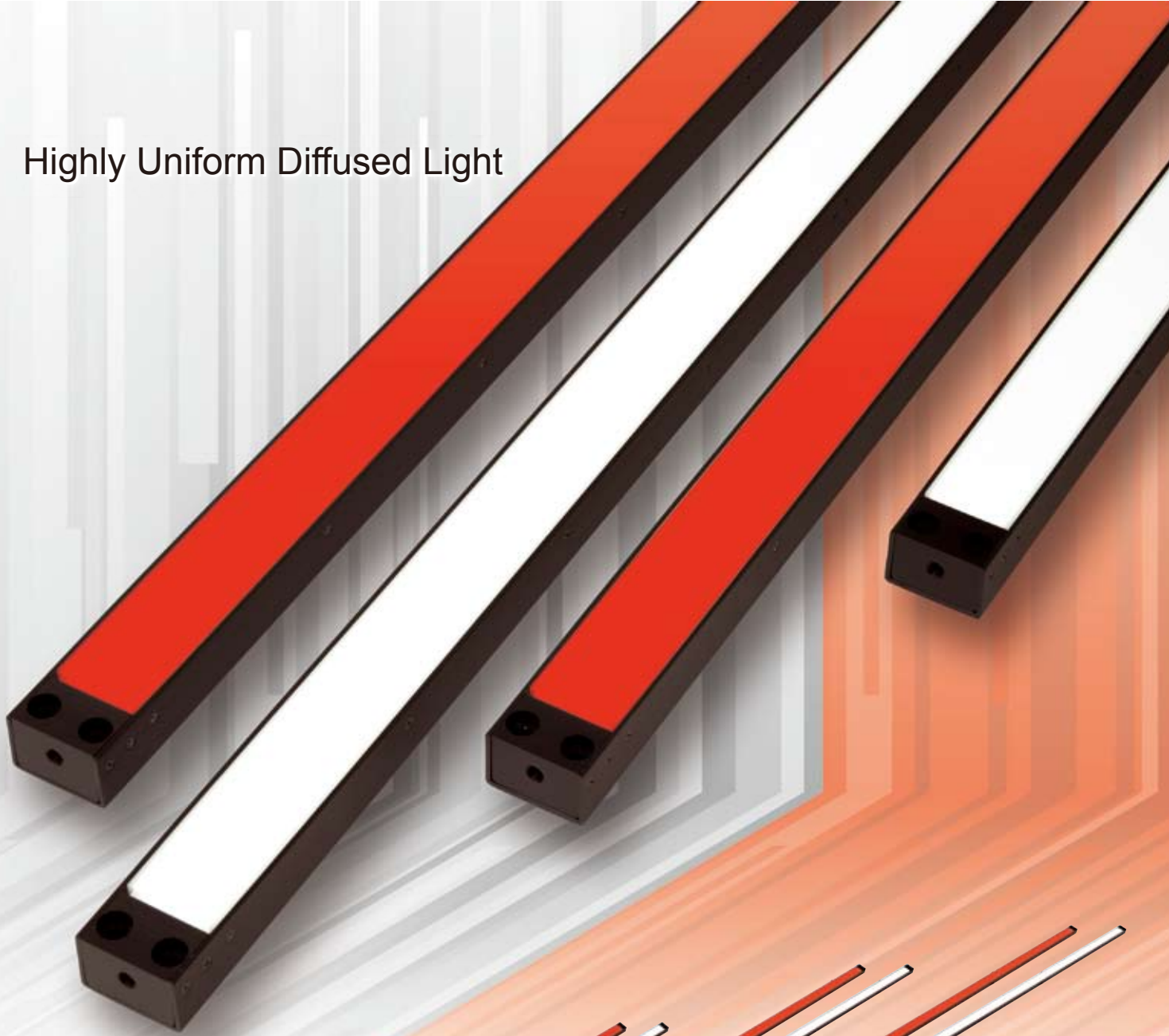

Red White  
LND2-300 Series



Red White  
LND2-600 Series



Red White  
LND2-900 Series



Red White  
LND2-1200 Series

# LED Light Units for Line Scan

## LND2 Series



### Suitable for All Types of Line Sensor Inspections

#### Application Examples

Scratch and Dent Inspections for Motor Shafts



Foreign Matter Inspections for Transparent Film



#### Reduce Equipment Costs

The LED Light Units provide bright uniform illumination for line sensors at a low cost. They can be used for a wide range of inspections, and they help to reduce equipment costs.

##### Price

Price Comparison for CCS Products

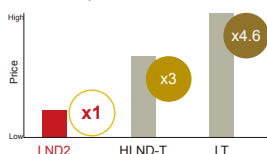

\* The following models were compared: LND2-300SW, HLND-300SW2-T, and LT-300SW.

##### Brightness

Brightness Comparison for CCS Products (White Light)

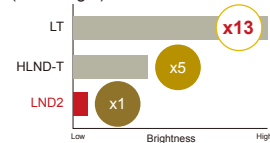

\* The following models were compared: LND2-300SW, HLND-300SW2-T, and LT-300SW.

#### The Ideal Solution to Replace Fluorescent Lights

The long life of LEDs means that they will not burn out like fluorescent lights. This eliminates the cost and work involved in replacing fluorescent lights.

##### Calculated Life

Life Comparison between Fluorescent and LND (Red) Lights

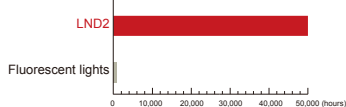

\* Calculated value until the light output decreases to 50% at a light intensity of 100% and an ambient temperature of 25°C. (The values are for reference only.)

##### Replacement Work

Change in LED Light Intensity and Replacement Work for Fluorescent Lights

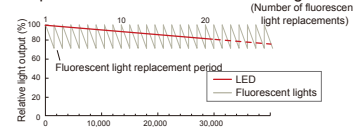

\* This comparison illustrates the change in LED light output and fluorescent light replacement every 1,500 hours.

#### Product Line-up

Light Units are available with either red or white light. Models are also available with emitting surface lengths of 301, 603, 903, and 1,203 mm.

##### Emitting Surface Length

##### LED Color

●Red/○White

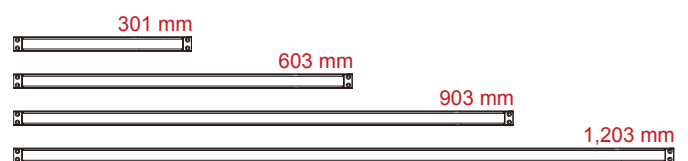

##### Custom Orders

Emitting Surface Length  
Orders accepted in increments of  
**100 mm.**

##### Custom Order Sizes

101, 201, 401, 603, 703, 803, 1,003, and 1,103 mm

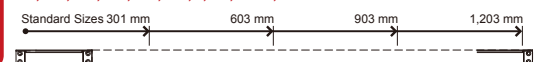

LED Color  
Orders accepted for  
**blue** light.

LED Color  
Orders accepted for  
**green** light.

You can order custom lights with emitting surface lengths that are multiples of 100 mm. You can also order blue or green LEDs. For details, please contact a CCS sales office.

## Luminance Distribution (Emitting Surface)

Light Units: LND2-600RD (red) and LND2-600SW (white)

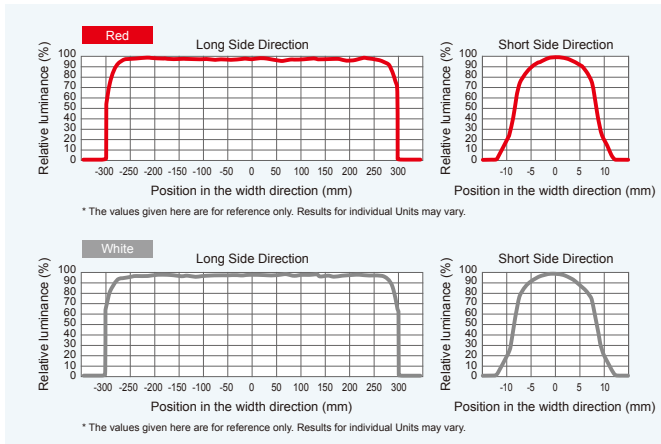

## Light Output Characteristics

Light Units: LND2-RD (red) and LND2-SW (white)

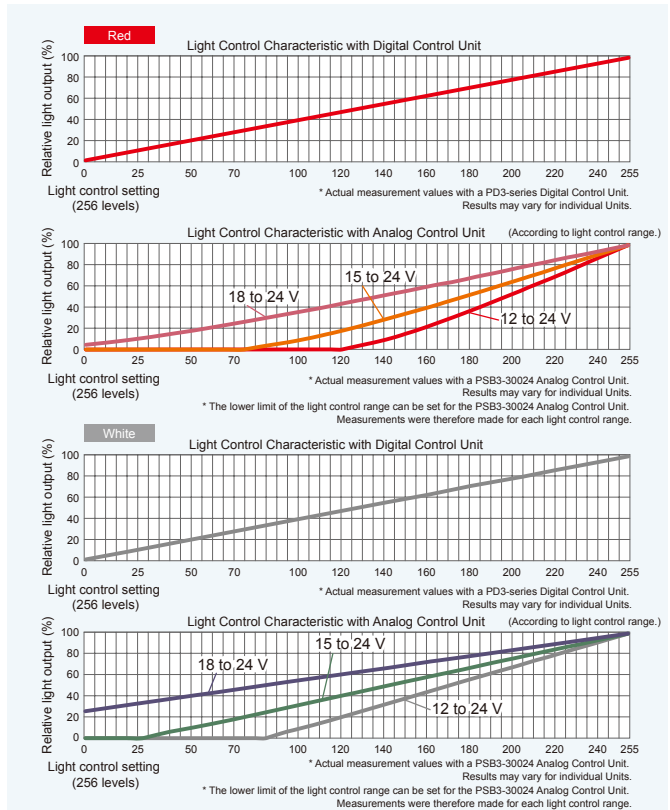

## Illuminance Graph

Light Units: LND2-300RD (red) and LND2-300SW (white)

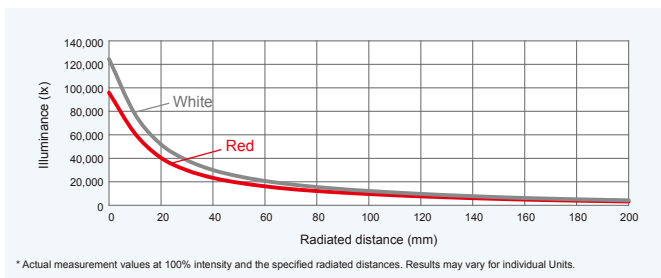

## Intensity Changes over Time

Light Units: LND2-300RD (red) and LND2-300SW (white)

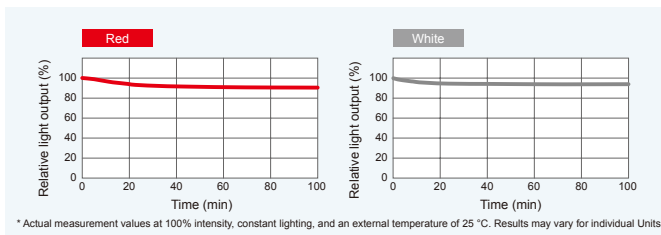

## Change in Light Intensity (Predicted Values)

Light Units: LND2-RD (red) and LND2-SW (white)

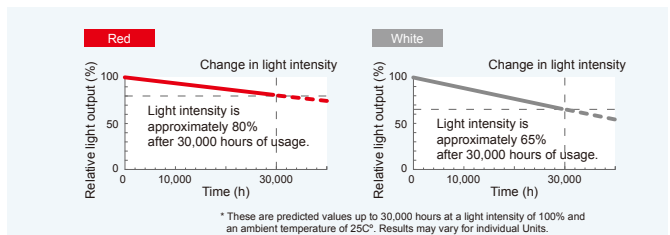

## Applicable Control Units

The Control Units that can be used depend on the model of the Light Unit in the LND2 Series. Select the model that is best for your application.

Model	LED color	Emitting surface length	Power consumption (max.)	Cable connector	Applicable Control Units			
					Analog Control Units		Digital Control Units	
					Model	Main specifications	Model	Main specifications
LND2-300RD	Red	301 mm	23 W	SM Connector	• PSB-3024VB • PSB-3024VBL	• Stepless light intensity control (variable voltage control) • No external control	PD3-series Control Units	• 256-level light intensity control (PWM control) • External control
LND2-300SW	White	301 mm	18 W		• PSB-3024VB • PSB-3024VBL	• Stepless light intensity control (variable voltage control) • No external control	PD3-series Control Units	• 256-level light intensity control (PWM control) • External control
LND2-600RD	Red	603 mm	46 W		For details, please contact a CCS sales office.			
LND2-600SW	White	603 mm	35 W					
LND2-900RD	Red	903 mm	69 W	EL Connector	PSB3-30024	• 256-level light intensity control (variable voltage control) • External control	PD3-10024-8 Control Units	• 256-level light intensity control (PWM control) • External control
LND2-900SW	White	903 mm	53 W		PSB3-30024	• 256-level light intensity control (variable voltage control) • External control	PD3-10024-8 Control Units	• 256-level light intensity control (PWM control) • External control
LND2-1200RD	Red	1,203 mm	91 W		PSB3-30024	• 256-level light intensity control (variable voltage control) • External control	PD3-10024-8 Control Units	• 256-level light intensity control (PWM control) • External control
LND2-1200SW	White	1,203 mm	70 W		PSB3-30024	• 256-level light intensity control (variable voltage control) • External control	PD3-10024-8 Control Units	• 256-level light intensity control (PWM control) • External control

\* Refer to the CCS website or to the machine vision product catalogs for the specifications of the Control Units.

\* For a PD3-series Digital Power Supply, we recommend a PWM frequency of 500 kHz (custom order).

# Specifications

\* Product Number Guide: You can easily access the information page for any of our products by entering the item's 7-digit product number in the designated box on the CCS website (image processing page).

LED color	Red (RD)	White (SW)
Peak emitted wavelength/ relative color temperature	630 nm (typ.)	5,500 K (typ.)
Input voltage	24 V DC (max.)	
Case material	Aluminum alloy, POM, and PMMA (Diffuser)	
Cable length	0.3 m	
Connector	Emitting surface length of 301 or 603 mm: SM Connector (SMR-03V-B) Emitting surface length of 903 or 1,203 mm: EL Connector (ELP-02V)	
Polarity and signals	SM Connector: 1: Anode (+), 2: NC, 3: Cathode (-) EL Connector: 1: Anode (+), 2: Cathode (-)	
Operating environment	Temperature: 0 to 40°C, Humidity: 20% to 85% RH (with no condensation)	
Storage environment	Temperature: -20 to 60°C, Humidity: 20% to 85% RH (with no condensation)	
CE Marking	Conforms to safety standard EN 62471.	
Cooling method	Natural air cooling	
Spectral distribution		

Direct number	Model	LED color	Emitting surface length	Power consumption (max.)	Weight (max.)	Dimension diagram
1005790	LND2-300RD	Red	301 mm	23 W	200 g	1
1005794	LND2-300SW	White	301 mm	18 W	200 g	
1005791	LND2-600RD	Red	603 mm	46 W	360 g	
1005795	LND2-600SW	White	603 mm	35 W	360 g	
1005792	LND2-900RD	Red	903 mm	69 W	505 g	2
1005796	LND2-900SW	White	903 mm	53 W	505 g	
1005793	LND2-1200RD	Red	1,203 mm	91 W	670 g	
1005797	LND2-1200SW	White	1,203 mm	70 W	670 g	

## Dimension Diagrams (mm)

### 1 LND2-300/600

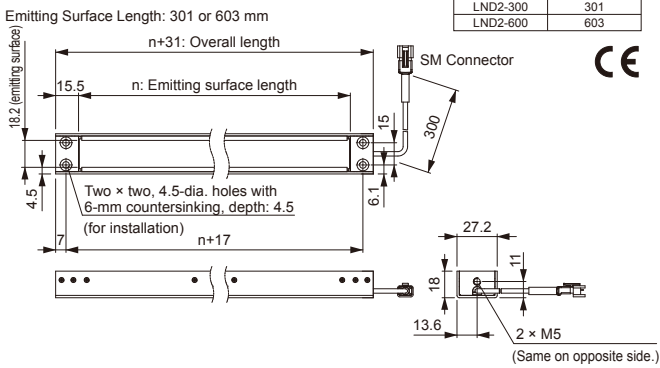

### 2 LND2-900/1200

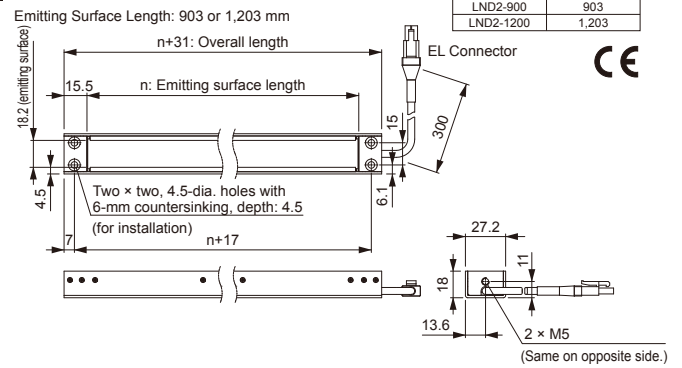

## Options

### Extension Cables for Models with Emitting Lengths of 301 or 603 mm (SM Connectors)

The connecting cable to the Light Unit is 300 mm long.  
Use the Extension Cable that is suitable for your installation site.

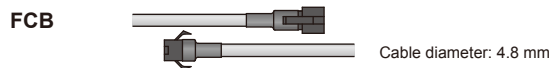

Direct number	3000122	3000140	3000150	3000158
Model	FCB-1	FCB-2	FCB-3	FCB-5
Cable length	1 m	2 m	3 m	5 m
Application	This cable is used to extend the distance between the Light Unit and the Control Unit.			

Caution: If the total cable length exceeds 5 m, the light intensity may become unstable.

### Extension Cables for Models with Emitting Lengths of 903 or 1,203 mm (EL Connectors)

The connecting cable to the Light Unit is 300 mm long.  
Use the Extension Cable that is suitable for your installation site.

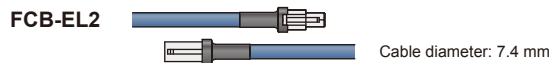

Direct number	3000690	3000766	3000691	3000692	3000693	3000760
Model	FCB-1-EL2	FCB-2-EL2	FCB-3-EL2	FCB-5-EL2	FCB-10-EL2	FCB-15-EL2
Cable length	1 m	2 m	3 m	5 m	10 m	15 m
Application	This cable is used to extend the distance between the Light Unit and the Control Unit.					

\*Refer to the CCS website or to the machine vision product catalogs for information on other optional cables.

● CCS and LIGHTING SOLUTION are all registered trademarks or trademarks of CCS, Inc.

### Caution

- To ensure proper and safe use of the product, please read the Instruction Guide completely before using the product.
- For product improvement, specifications and designs are subject to change without notice.