

3 Mega-Pixel Lens

Cinegon 1.8/4.8-0902

In accordance with the sensitivity of modern 2 / 3" CCD and CMOS sensors, the 3 megapixel lenses are corrected and broadband-coated for the spectral range of 400 – 1000 nm (VIS + NIR). Even under production and / or extreme conditions, the robust mechanical design with lockable focus and iris setting mechanism guarantees reliable continuous use in which the set optical parameters remain in place.



Cinegon 1.8/4.8

Key Features

- High-resolution optics
- Highest optical imaging performance even with smallest pixel sizes
- Broadband coating (400 - 1000 nm)
- Compact and low weight
- Vibration insensitivity for stable imaging performance
- Focus and iris setting lockable

Applications

- Machine Vision and other imaging applications
- 3D measurement
- Traffic
- Medical
- Robot vision
- Food processing

Technical Specifications

F-number	1.8
Focal length	5.0 mm
Image circle	11 mm
Transmission	400 - 1000 nm
Interface	C-Mount
Weight	90 gr.
Option	Filter holder with M62 x 0.75
Code no.	1001955

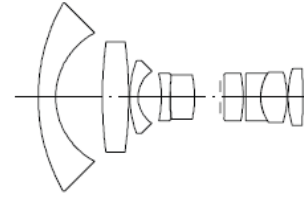
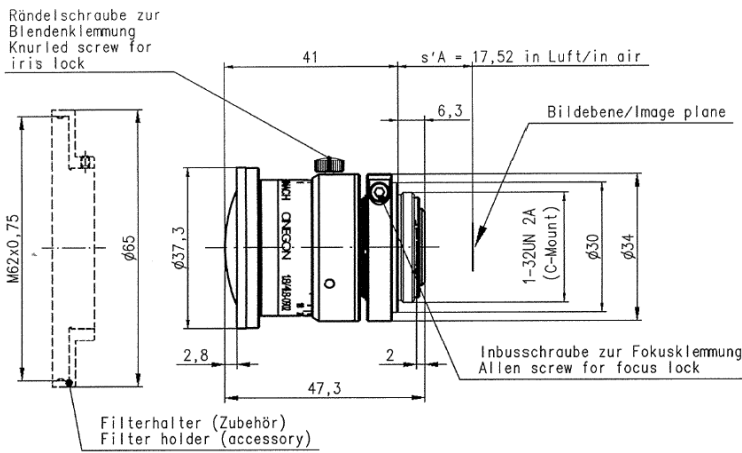

CINEGON 1.8/4.8

$f' = 5,0$ mm	$\beta'_p = 6,632$
$s_F = 13,2$ mm	$s_{EP} = 13,9$ mm
$s_{F'} = 13,2$ mm	$s_{AP} = -19,8$ mm
$HH' = 35,4$ mm	$\Sigma d = 45,3$ mm

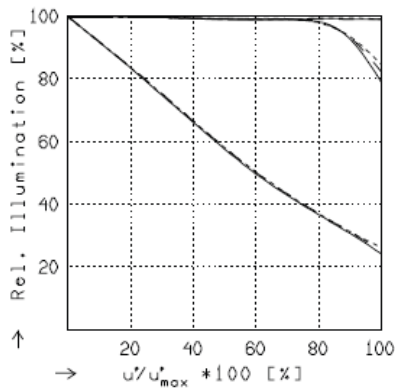

RELATIVE ILLUMINATION

The relative illumination is shown for the given focal distances or magnifications.

	$f / 1.9$	$f / 4.0$	$f / 8.0$
— $\beta' = -0.0200$	$u'_{max} = 5.5$	$00' = 294.$	
- - $\beta' = -0.0333$	$u'_{max} = 5.5$	$00' = 195.$	
--- $\beta' = -0.0500$	$u'_{max} = 5.5$	$00' = 145.$	

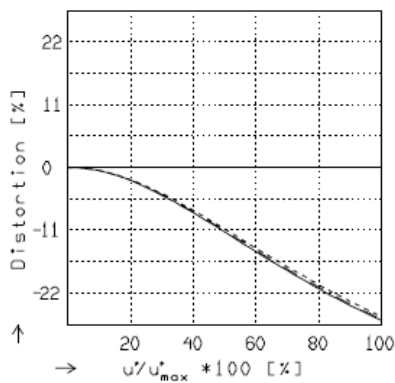

DISTORTION

Distortion is shown for the given focal distances or magnifications. Positive values indicate pincushion distortion and negative values barrel distortion.

— $\beta' = -0.0200$	$u'_{max} = 5.5$	$00' = 294.$
- - $\beta' = -0.0333$	$u'_{max} = 5.5$	$00' = 195.$
--- $\beta' = -0.0500$	$u'_{max} = 5.5$	$00' = 145.$

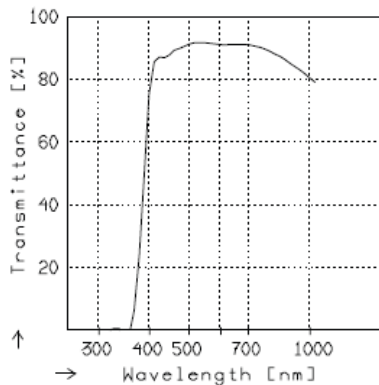

TRANSMITTANCE

Relative spectral transmittance is shown with reference to wavelength.

CINEGON 1.8/4.8

MODULATION with reference to the relative image height

Wavelength λ	[nm] :	555	655	605	505	455	405
Spectral weighting	[%] :	19.4	23.2	21.7	15.4	11.8	8.5
Spatial frequency R	[1/mm] :	10	20	30			
Format	[mm X mm] :	6.6	X	8.8			
Diagonal $2u'$	[mm] :	11.0					

radial —
tangential - -

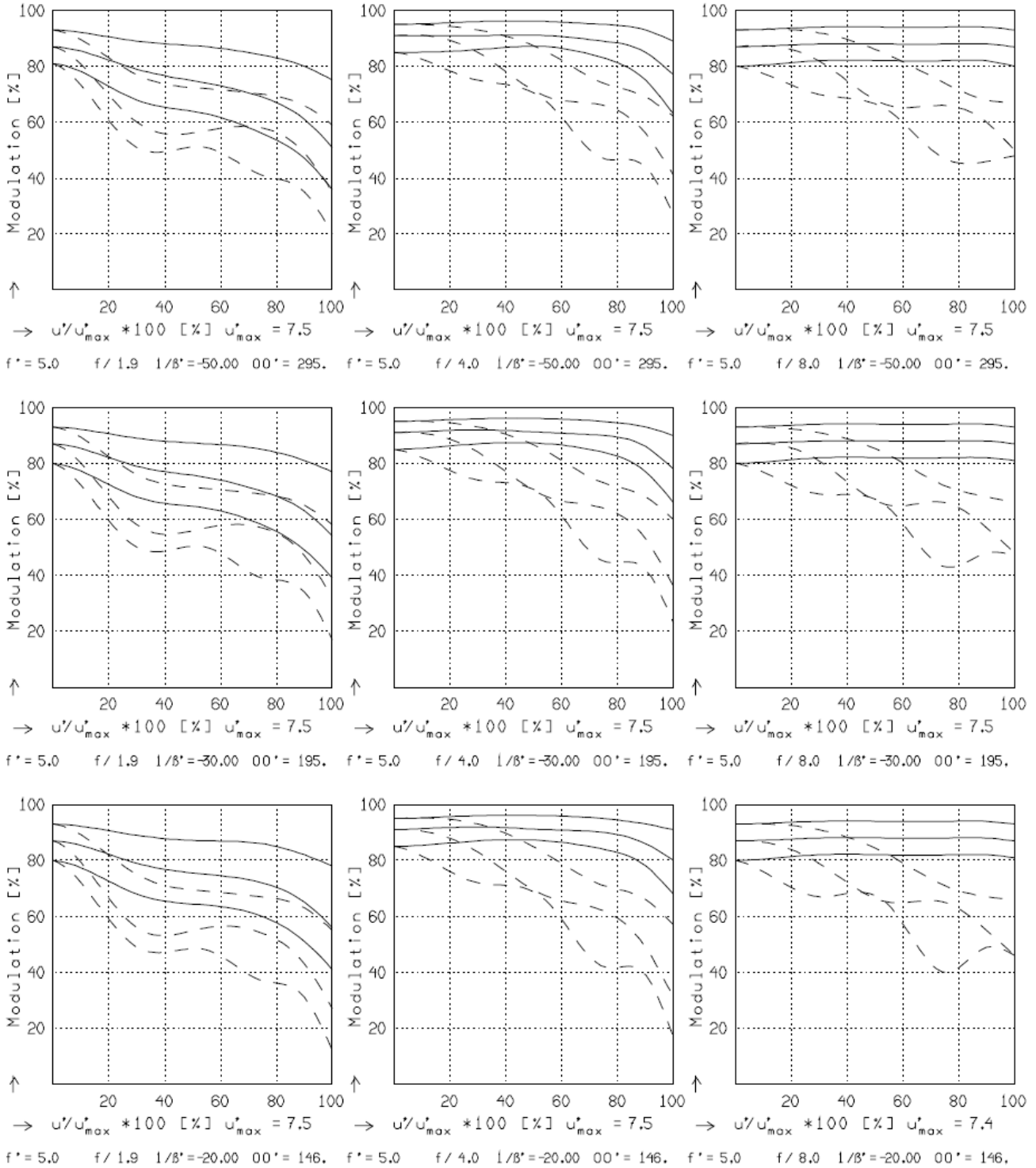

Focusing : MTF_{max} at $f / 1.8$, $R = 30$ 1/mm, $u'/u'_{max} = 0$

CINEGON 1.8/4.8

MODULATION with reference to the relative image height

Wavelength λ	[nm] :	555	655	605	505	455	405
Spectral weighting	[%] :	19,4	23,2	21,7	15,4	11,8	8,5
Spatial frequency R	[1/mm] :	10	20	30			
Format	[mm X mm] :	6,6	X	8,8			
Diagonal $2u'$	[mm] :	11,0					

radial —
tangential - -

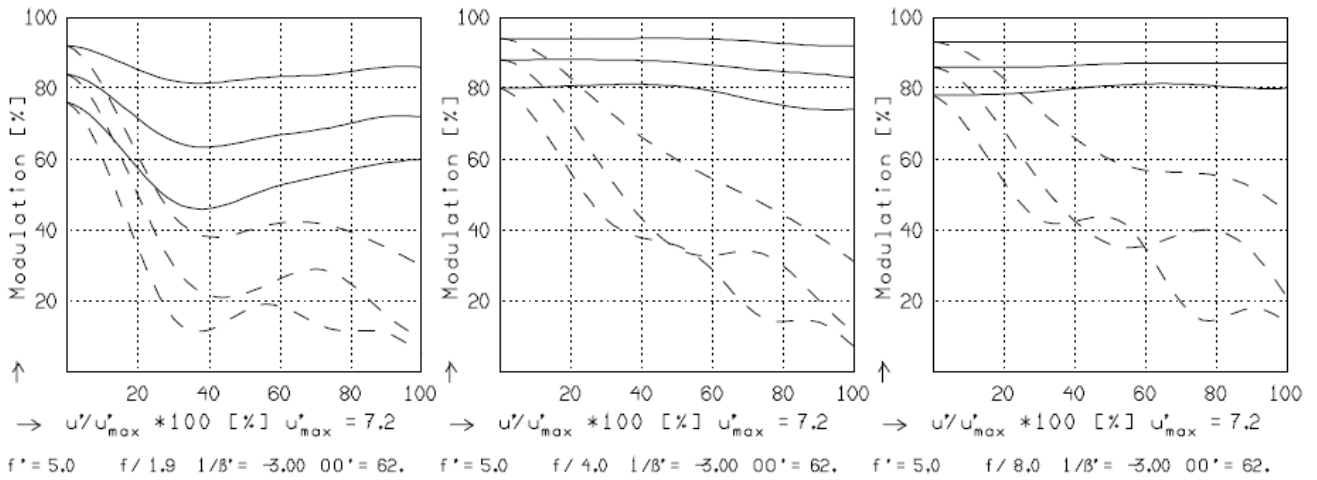
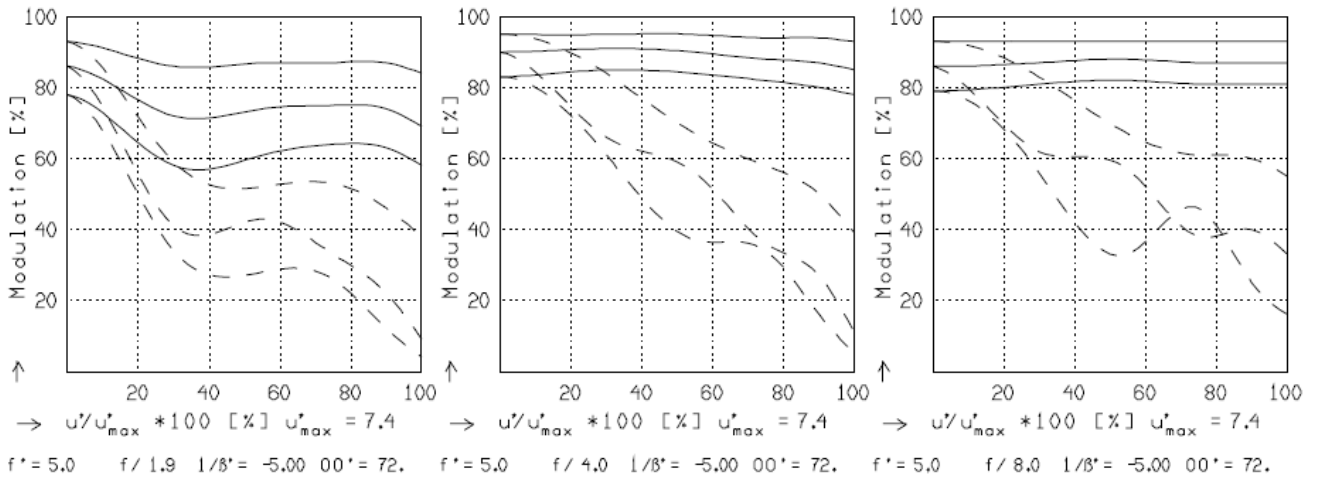
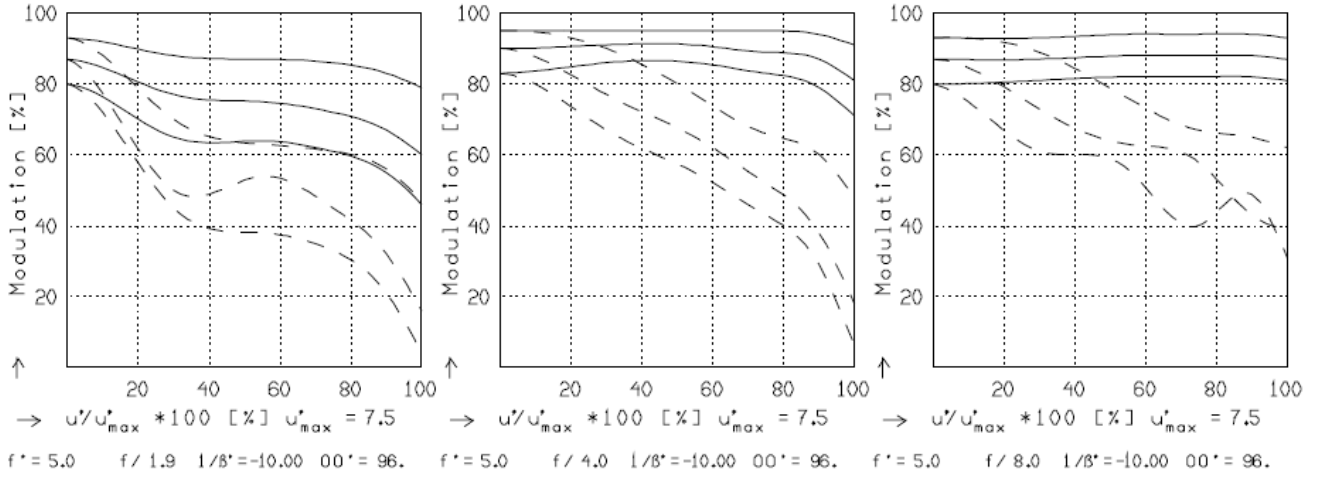

Focusing : MTF_{max} at $f / 1.8$, $R = 30$ 1/mm, $u'/u'_{max} = 0$