

# TCCAGE23048

Bi-telecentric multi-mirror system for 2/3"

## SPECIFICATIONS

Detector type		2/3"
Max. object diameter	(mm)	8
Max. object height	(mm)	32
Optical specifications		
Wavelength range	(nm)	450 .. 650
CTF @ 70 lp/mm	(%)	> 40
f/#		8
Mechanical specifications		
Width	(mm)	111
Length	(mm)	192.8
Height	(mm)	248
Mass	(g)	2700
Mount		C
Electrical specifications		
Ring illumination voltage	(V, DC)	24
Ring illumination power	(W)	3
Coaxial illumination voltage	(V, DC)	24
Coaxial illumination power	(W)	9
Cable		CB244P1500 included

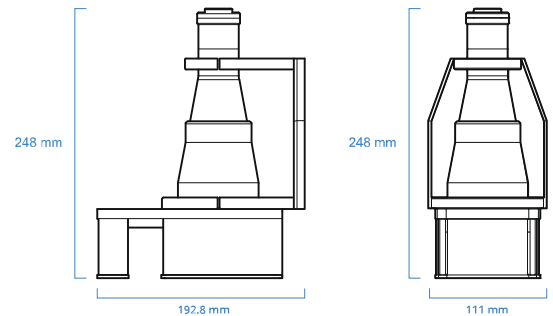
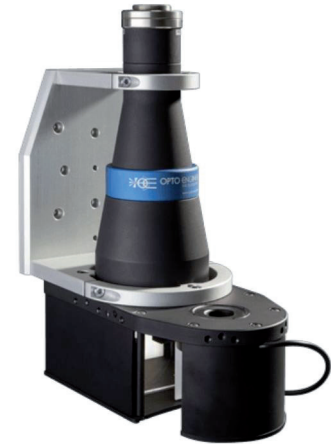

## CONNECTION

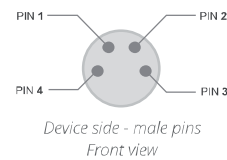

### Pinout reference

PIN	FUNCTION
1	-
2	GND
3	-
4	Power supply (+24 V)



## COMPATIBLE PRODUCTS



LTRN050W45  
Ring LED illuminator, white