

This lens combines an approved Schneider Lens and one of Optotunes Focus Tunable Lenses EL-16-40-TC. It comes in four versions for C-Mount and TFL-Mount, each Mount for two different working distances. Short Version (SD) is suitable from appr. 320mm to 900mm working distance, Long Version (LD) is optimized for applications at appr. 400mm and farer distances.

Key features	Applications
<ul style="list-style-type: none"> • Focus tunable liquid lens included • Large working distance range • Fast focus within milliseconds • Large image circle 	<ul style="list-style-type: none"> • Machine Vision • Package sorting / logistic • Bar code reading • Quality control

Technical specifications	
Type [liquid lens focus, long distance]	TFL-LF-LD
ID [liquid lens focus, long distance]	1102611
Interface	TFL-Mount
Focal length [mm]	80
F/# range	F/4 ... F/45
Numerical aperture [object image]	- 0.09
Max. sensor size [mm]	40
Max. angle of view [°]	27
Rec. magnification range	-0.20 ... 0
Rec. working distance range [mm]	393 ... ∞
Min. working distance without extension tubes [mm]	330
Filter thread [mm]	M37 x 0.75
Storage temperature [°C]	-25 ... +70
Net. weight [standard] [g]	-
Additional info	Data dependent on liquid lens settings
f'eff [mm]	71.58 ... 90.48
SF [mm]	-46.40 ... -72.70
S'F' [mm]	49.18 ... 62.66
HH' [mm]	-1.47 ... 0.50
β'P	1.17 ... 1.03
SEP [mm]	14.74
S'AP [mm]	-34.63 ... -30.99
Σd [mm]	50.12

MTF charts

Spectrum name	VIS					
Wavelengths [nm]	425	475	525	575	625	675
Rel. weights [%]	8	16	23	22	19	13

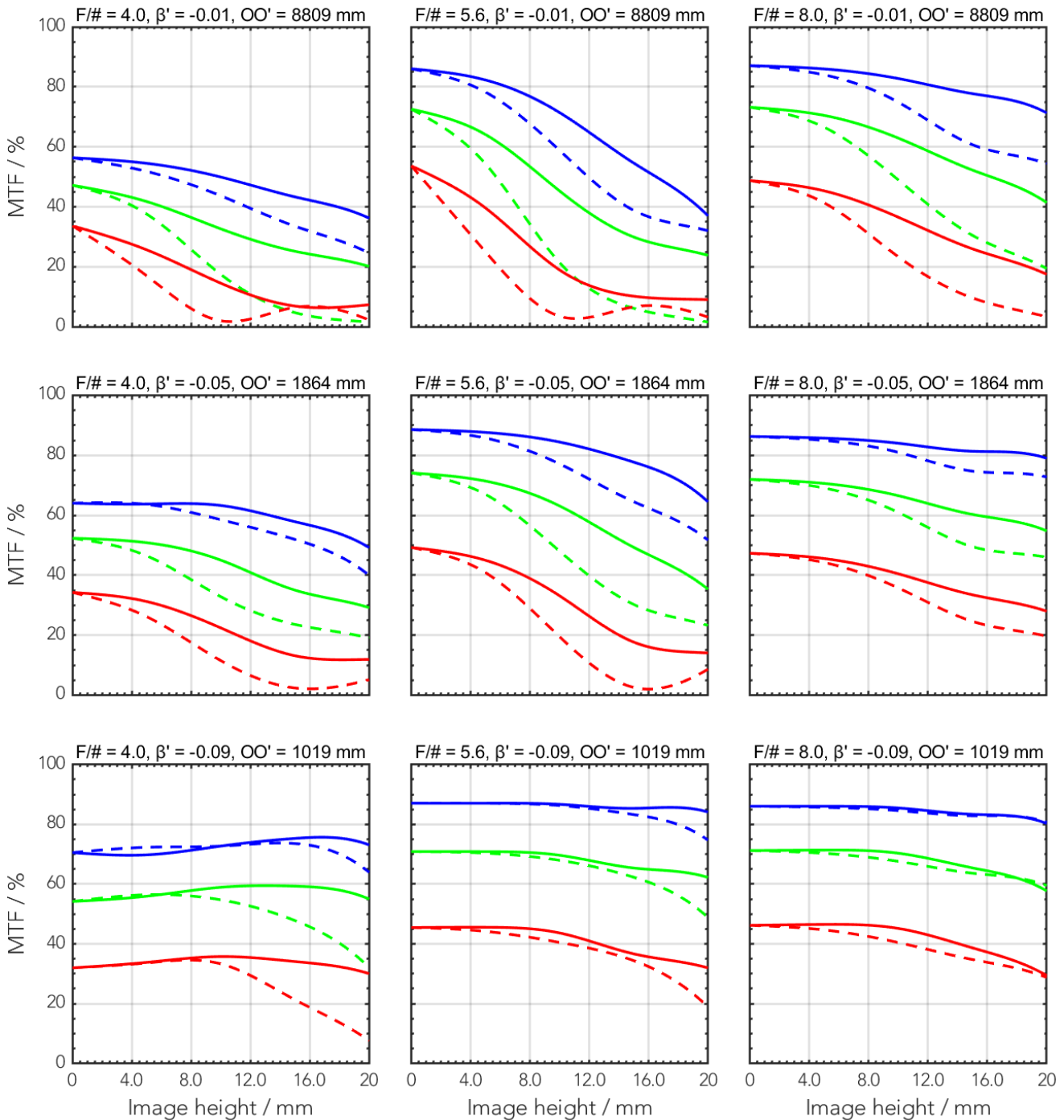

— 20 LP/mm, radial — 40 LP/mm, radial — 80 LP/mm, radial
- - - 20 LP/mm, tangential - - - 40 LP/mm, tangential - - - 80 LP/mm, tangential

MTF charts

Spectrum name	VIS					
Wavelengths [nm]	425	475	525	575	625	675
Rel. weights [%]	8	16	23	22	19	13

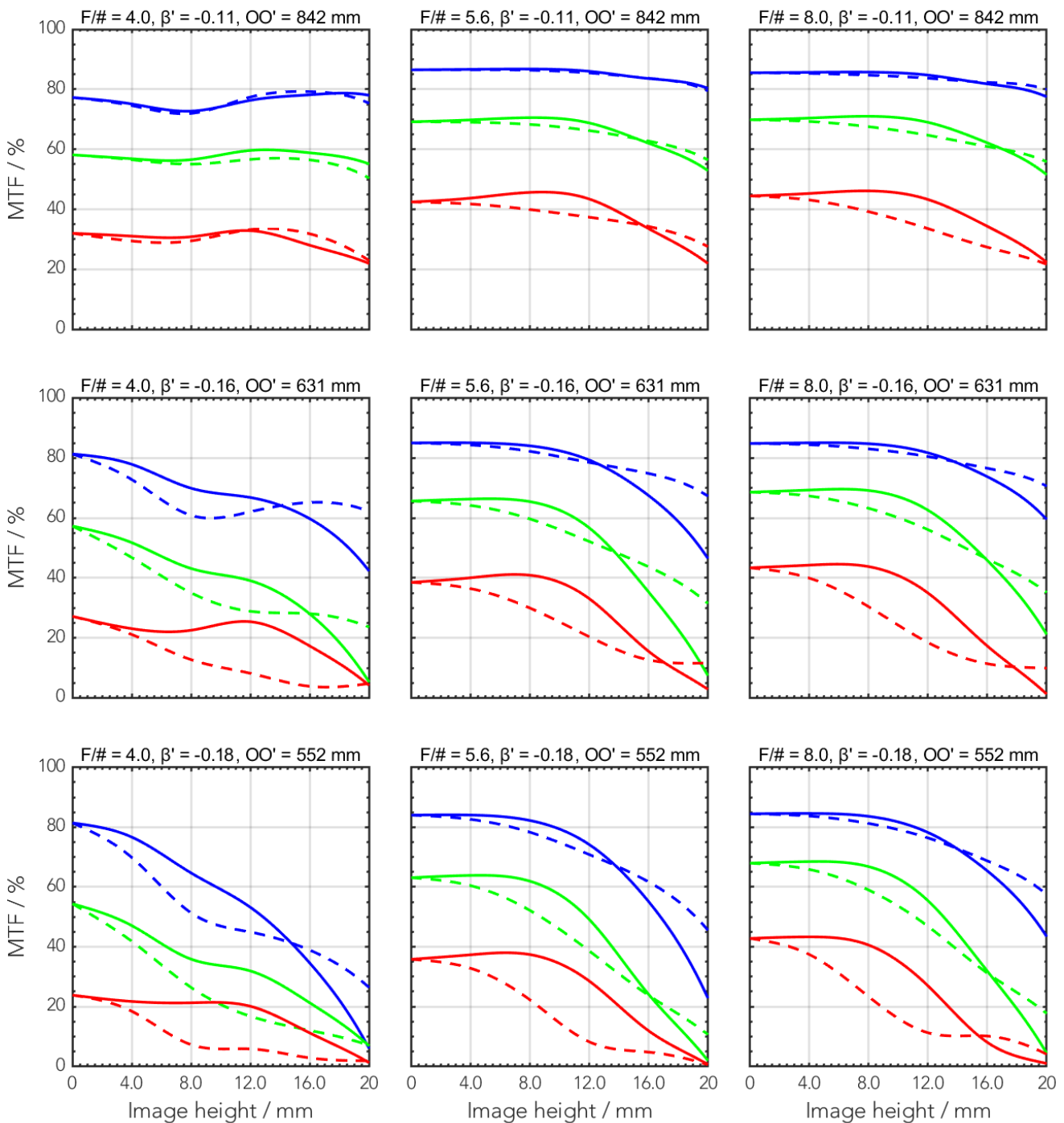

— 20 LP/mm, radial — 40 LP/mm, radial — 80 LP/mm, radial
- - - 20 LP/mm, tangential - - - 40 LP/mm, tangential - - - 80 LP/mm, tangential

Rel. illumination vs. image height

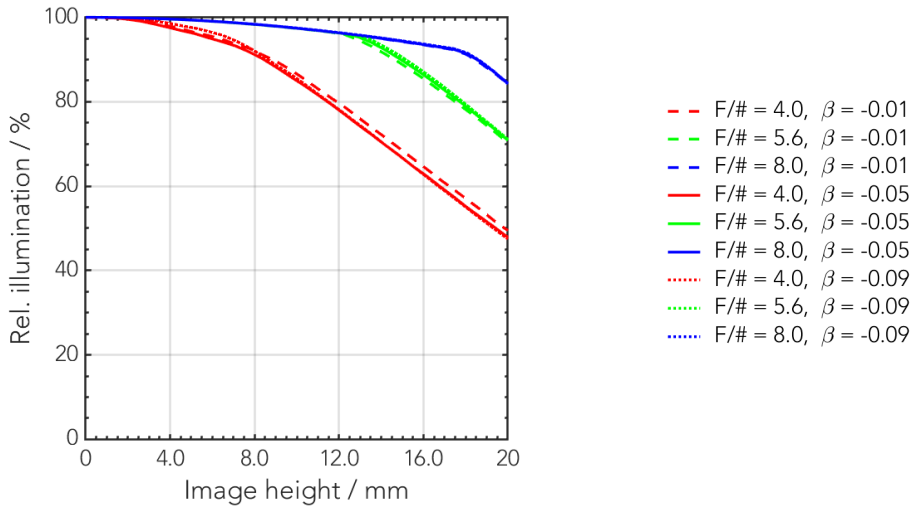

Distortion vs. image height

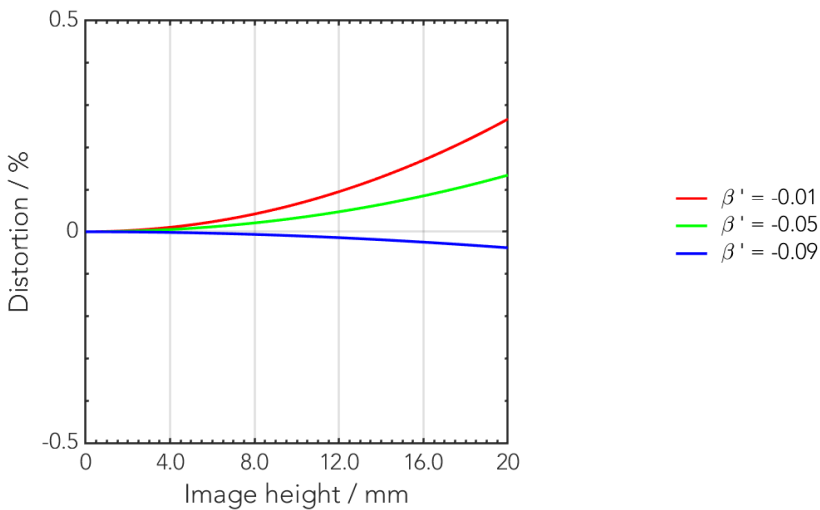

Rel. illumination vs. image height

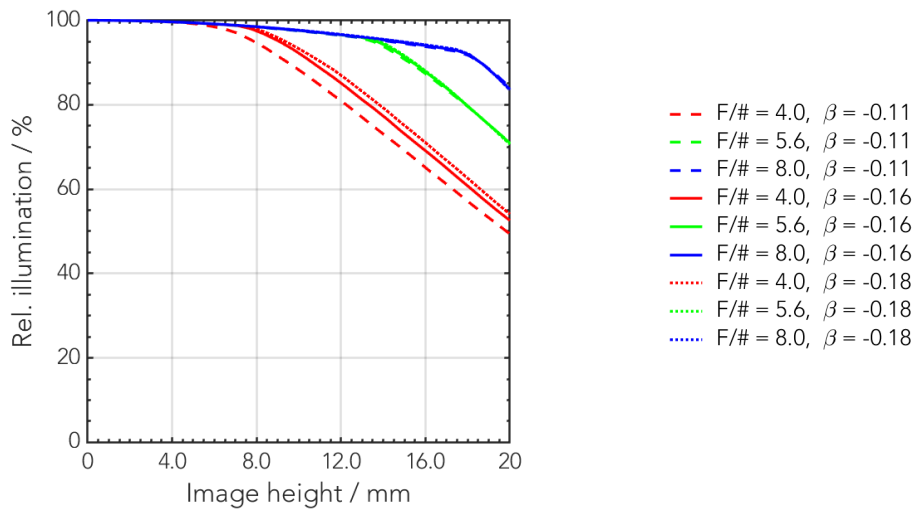

Distortion vs. image height

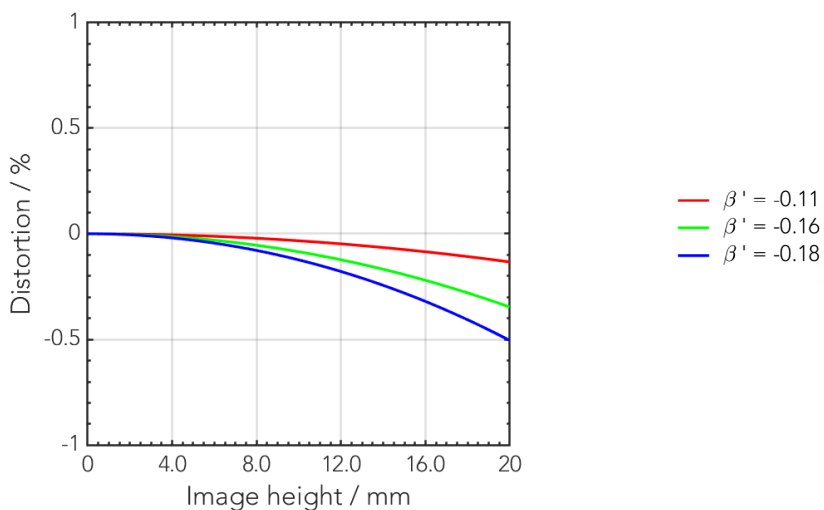

Transmittance vs. wavelength

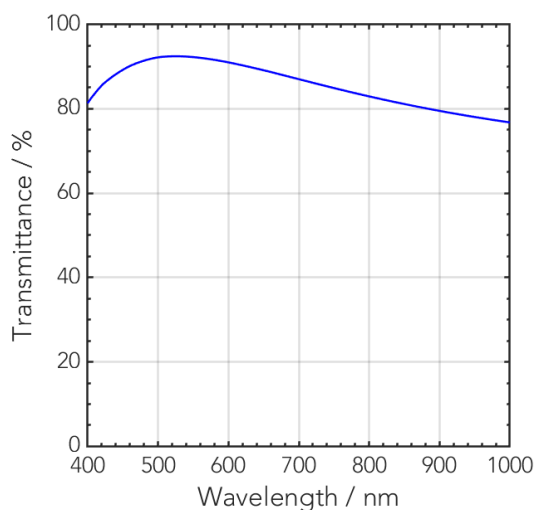

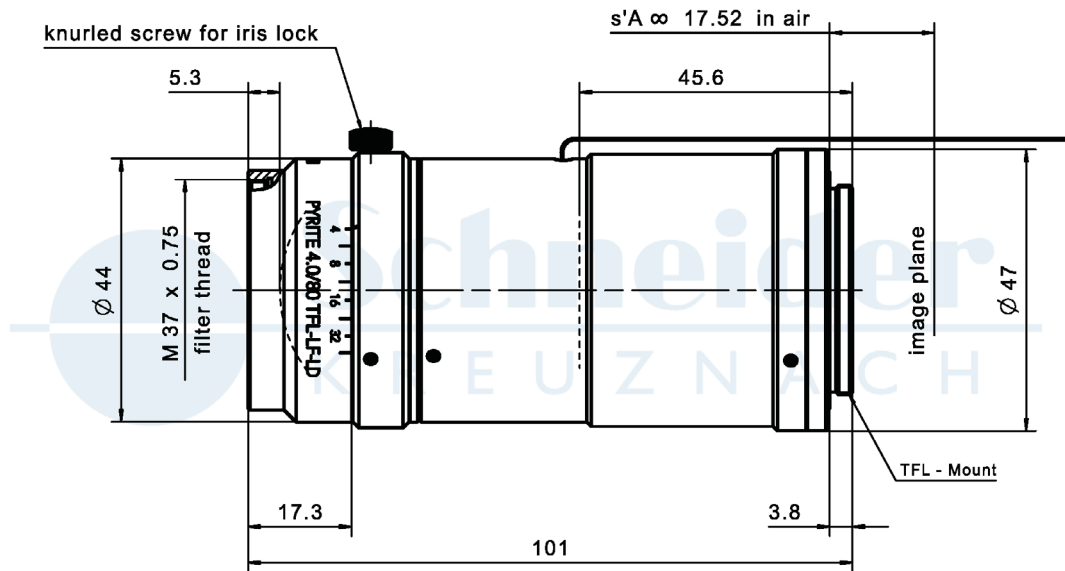

Annotation	
Focal length	Nominal focal length
F/# range	Image space F-number range for infinity focus position
Numerical aperture	Maximum real numerical aperture (depending on recommended magnification range either for infinity or respective fixed magnification)
Max. sensor size	Image circle diameter
Max. angle of view	Angle of view associated with maximum sensor size (depending on recommended magnification range either for infinity or respective fixed magnification)
Rec. magnification range	Magnification range as recommended by Schneider-Kreuznach
Rec. working distance range	Working distance, i.e. distance between object and first mechanical element, associated with recommended magnification range
Max. mechanical focus travel	Maximum possible movement of the lens from infinity position (depending on recommended magnification range either for infinity or respective fixed magnification)
Net weight	weight of unpacked lens without lens cap
f'_{eff}	Effective focal length
SF	Distance between vertex of first lens surface and object space focal point
S'F'	Distance between vertex of last lens surface and image space focal point (back focal distance at infinity)
HH'	Distance between principal planes
$\beta'P$	Pupil magnification (= exit pupil diameter / entrance pupil diameter)
SEP	Distance between vertex of first lens surface and entrance pupil
S'AP	Distance between vertex of last lens surface and exit pupil
Σd	Distance between vertices of first and last lens surface
s'A	Flange focal distance (in air) for infinite object distance (depending on recommended magnification range either for infinity or respective fixed magnification)
β'	Magnification (= image size / object size), negative value because image is inverted
OO'	Distance between object and image

Unless otherwise stated all dimensions in this data sheet are in mm.