

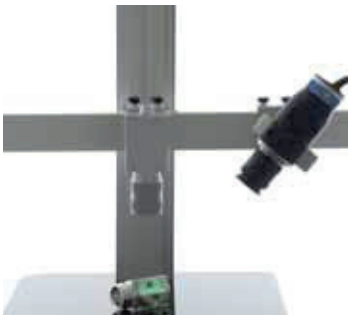

LTPRSM Series are LED Pattern Projectors specifically designed for the most demanding 3D profiling and measurement applications. Triangulation techniques require that structured light be directed onto a sample at a considerable angle from vertical. Tilting the light source pattern becomes essential to ensure that patterned light is properly and homogeneously focused across the entire sample surface. LTPRSM pattern projectors integrate a precision tilting mechanism based on the Scheimpflug criterion. This also ensures that the focus doesn't change when the pattern is tilted. Moreover, the internal focus mechanism offers the maximum optical throughput. The projected light path is effectively coupled to the pupil aperture of any C-mount lens.



EXAMPLES OF 3D MEASUREMENT SET-UPS



LTPRSM pattern projector with a standard C-mount lens.

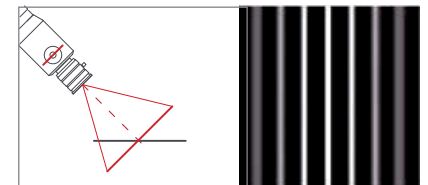

Without tilt adjustment, the pattern features are only partly focused.

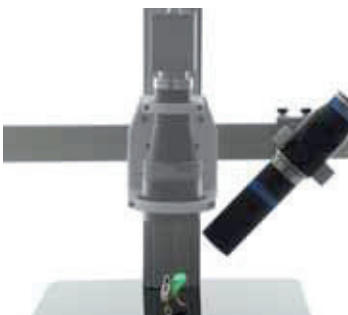

Bi-telecentric lenses used for both projection and vision.

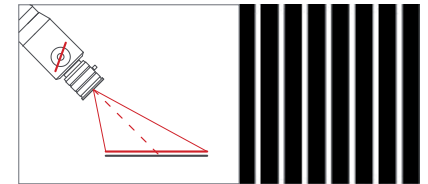

With the Scheimpflug adjustment, focus is maintained across the entire plane.

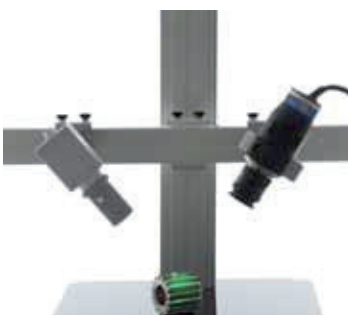

90° configuration with zero distortion macro lenses.



KEY ADVANTAGES

SCHEIMPFLUG TILT ADJUSTMENT

For homogeneous focusing of the pattern features.

TILT ADJUSTMENT COMPATIBLE WITH C-MOUNT OPTICS

Focus is maintained even when the pattern is tilted.

LIGHT CONDENSER FOCUSING MECHANISM

For excellent optical coupling and light throughput.

ENHANCED OPTICAL POWER

Due to the high numerical aperture condenser lens.

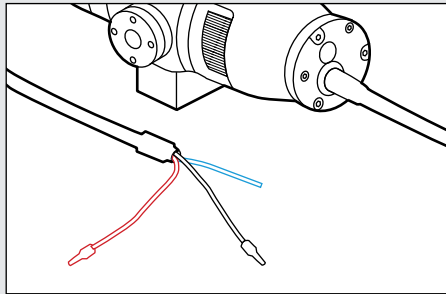
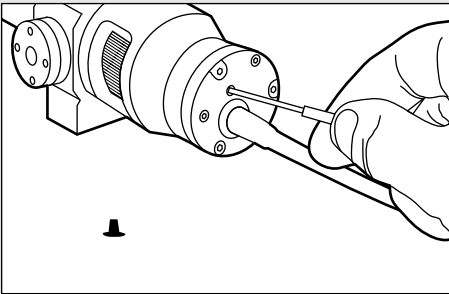
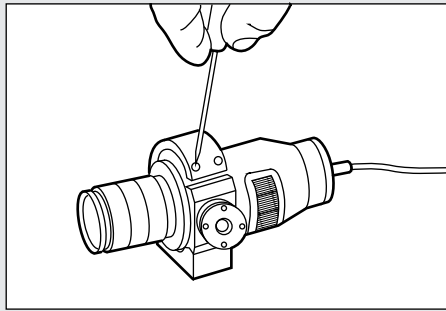
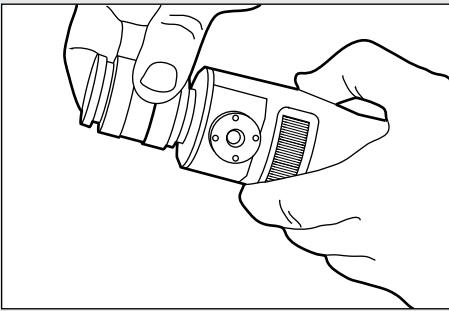
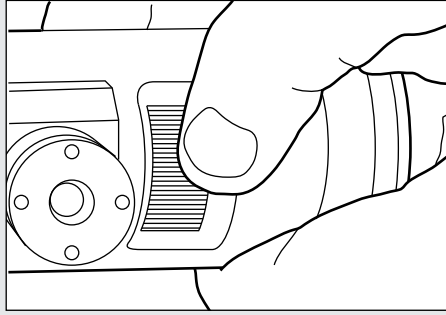
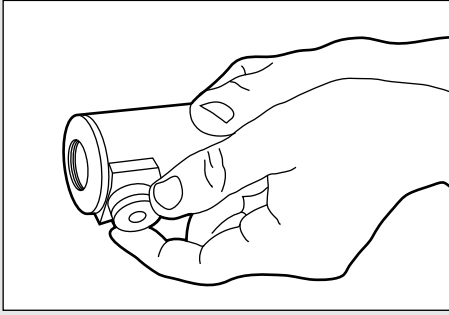

The pattern tilt control is easily tuned by means of a click-stop knob with 2.5° sensitivity to precisely meet the Scheimpflug condition. The optimum coupling with any C-mount lens is obtained with the internal focus mechanism. The LED source is imaged into the lens aperture to achieve maximum optical throughput.

LTPRSM projectors are compatible with any 2/3" C-mount lens; the lens is simply screwed into the device just like with a C-mount camera. A simple mechanical mount specifically designed to clamp LTPRSM projectors is included into the product package.

Built-in switching electronics controls and stabilizes the amount of current in the device. The brightness level can be easily tuned by means of the integrated trimmer. Moreover, the inner circuitry can be bypassed in order to directly drive the LED: just wire the black and blue cables to the power supply instead of the black and brown ones and make sure that the maximum rates are not exceeded.

Part Number	OPTICAL PROPERTIES		DEVICE POWER RATINGS			LED POWER RATINGS		
	Light Color, Peak Wavelength	Output Flux (lumen)	Minimum DC Voltage (volt)	Maximum DC Voltage (volt)	Power Consumption (watt)	Forward Voltage (volt)	Forward Current (mA)	Pulse Ratings @0,1 duty/1kHz (mA)
LTPRSM3W/R	red, 630 nm	> 11,4	12,0	24,0	< 2	2,3	350,0	< 1800
LTPRSM3W/G	green, 520 nm	> 19	12,0	24,0	< 2	3,5	350,0	< 1800
LTPRSM3W/B	blue, 460 nm	> 4,5	12,0	24,0	< 2	3,5	350,0	< 1800
LTPRSM3W/W	white	> 21	12,0	24,0	< 2	3,5	300,0	< 1800

TYPICAL EMISSION SPECTRUM OF WHITE AND R,G,B LEDs

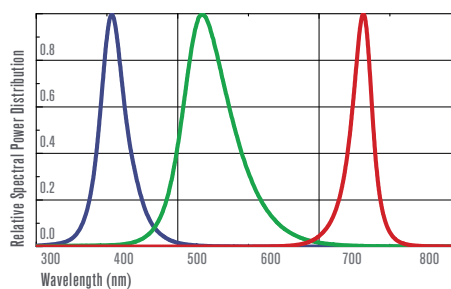
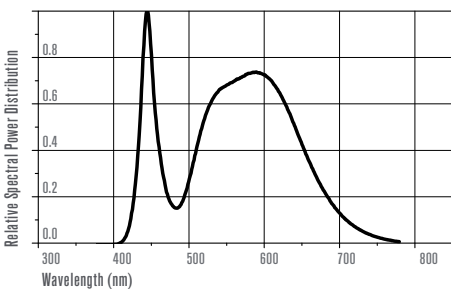



The projection pattern inside the unit can be changed and integrated with ease: just remove the C-mount adaptor by loosening the set-screws and fix the pattern by screwing the retaining ring.

Different types of stripe and grid patterns are available; the chart below shows the line thickness (0,05 mm) and the gap between neighboring lines for each pattern type.

When these features are projected, they become 1/M times larger, with "M" being the magnification of the projection lens. The number of lines mentioned after each part number indicates the number of features on the active area of the pattern.



PATTERN SELECTION MATRIX			
Substrate	soda lime glass	Geometrical Accuracy	50 micron
Coating	Chrome	Edge Sharpness	50 micron

STRIPE PATTERNS

PT 0000 0300 P: 8 lines in projection area

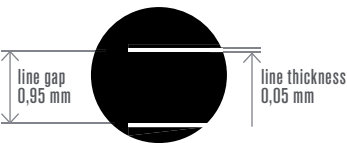

PTST 050 450 P: 16 lines in projection area



PTST 050 200 P: 32 lines in projection area



PTST 050 100 P: 53 lines in projection area



PTST 050 050 P: 80 lines in projection area



GRID PATTERNS

PT 0000 0400 P: 8 x 8 lines in projection area

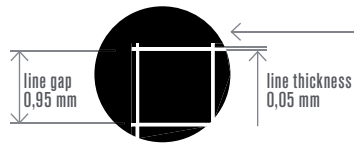

PRGR 050 450 P: 16x16 lines in projection area



PTGR 050 200 P: 32x32 lines in projection area

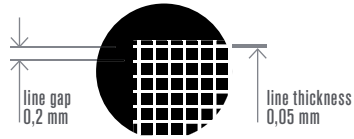

PTGR 050 100 P: 53x53 lines in projection area

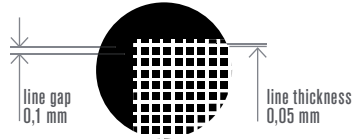

PTGR 050 050 P: 80x80 lines in projection area

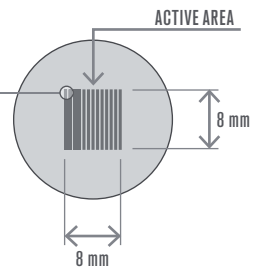
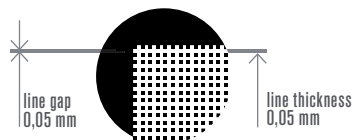

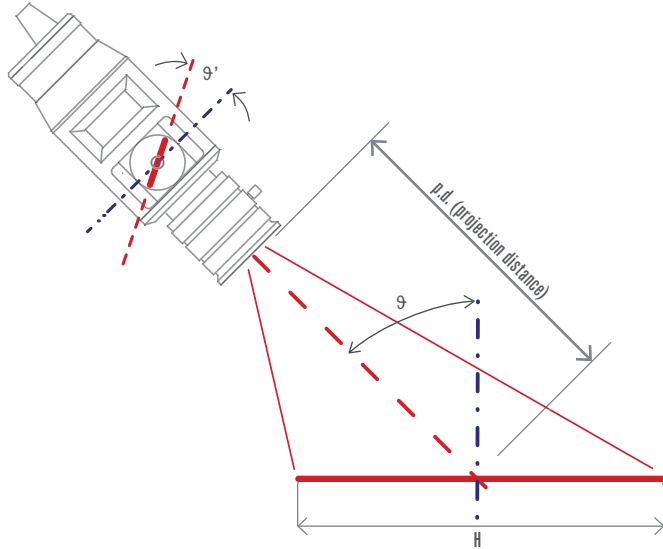

LTPRSM units can be interfaced with any type of optics, but the best results are achieved with bi-telecentric lenses. The projection area is undistorted since tilting the pattern only causes a linear extension along one direction. Very good results can also be obtained with zero distortion macro lenses; here, the magnification changes along both axes, but image resolution and distortion are such that 3D reconstruction can still be easily performed. With non bi-telecentric lenses, a square pattern becomes a trapezoid in the projection plane, whose parallel sides are indicated as “w” and “W” in the “MACRO” chart below. The projection data shown in the chart are also a good approximation for standard C-mount lenses used as macro lenses (eventually equipped with spacers).

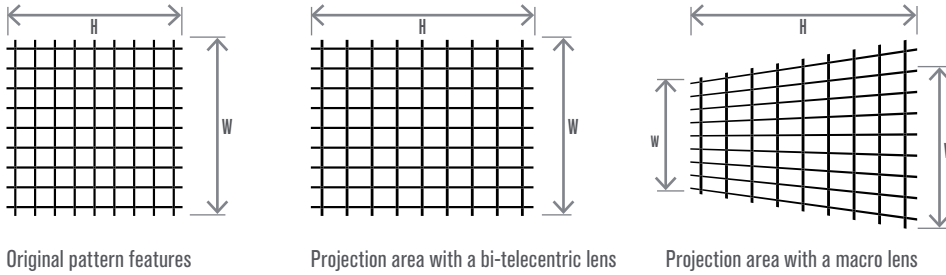

PROJECTION AREA WITH BI-TELECENTRIC LENSES (TC SERIES)

Part Number	Projection Distance (mm)	ϑ = 0°				ϑ = 15°				ϑ = 30°				ϑ = 45°			
		Projection Area			Pattern Tilt ϑ'	Projection Area			Pattern Tilt ϑ'	Projection Area			Pattern Tilt ϑ'	Projection Area			Pattern Tilt ϑ'
		w	x	h	ϑ'	w	x	h	ϑ'	w	x	h	ϑ'	w	x	h	ϑ'
TC23009	63,3	8,0	x	8,0	0°	8,0	x	8,0	15,0°	8,0	x	8,0	30,0°	8,0	x	8,0	45,0°
TC23016	45,3	15,2	x	15,2	0°	15,2	x	15,4	8,1°	15,2	x	16,8	17,0°	15,2	x	20,0	27,8°
TC23024	69,2	22,9	x	22,9	0°	22,9	x	23,6	5,4°	22,9	x	26,0	11,4°	22,9	x	30,5	19,3°
TC23036	103,5	32,9	x	32,9	0°	32,9	x	34,0	3,7°	32,9	x	37,7	8,0°	32,9	x	45,3	13,6°
TC23048	134,6	43,3	x	43,3	0°	43,3	x	44,7	2,8°	43,3	x	49,8	6,1°	43,3	x	60,3	10,5°
TC23056	159,3	51,0	x	51,0	0°	51,0	x	52,8	2,4°	51,0	x	58,6	5,1°	51,0	x	71,3	8,8°
TC23064	182,0	58,2	x	58,2	0°	58,2	x	60,3	2,1°	58,2	x	67,1	4,5°	58,2	x	81,7	7,8°
TC23080	227,0	72,7	x	72,7	0°	72,7	x	73,8	1,7°	72,7	x	83,6	3,6°	72,7	x	102,0	6,3°
TC23096	279,0	85,6	x	85,6	0°	85,6	x	88,6	1,4°	85,6	x	98,7	3,1°	85,6	x	120,9	5,3°



PROJECTION AREA WITH MACRO (MC3-03X AND MC SERIES) AND STANDARD LENSES

	Projection Distance (mm)	ϑ = 0°				ϑ = 15°				ϑ = 30°				ϑ = 45°							
		Projection Area			Pattern Tilt ϑ'	Projection Area			Pattern Tilt ϑ'	30,0°			Pattern Tilt ϑ'	Projection Area			Pattern Tilt ϑ'				
		w	(W)	x	H	ϑ'	w	(W)	x	H	ϑ'	w	(W)	x	H	ϑ'	w	(W)	x	H	ϑ'
1 x	46,0	8,0	(8,0)	x	8,0	0°	7,7	(8,3)	x	8,0	15,0°	7,5	(8,6)	x	8,1	30,0°	7,3	(8,9)	x	8,1	45,0°
0,75 x	48,0	10,7	(10,7)	x	10,7	0°	10,3	(11,1)	x	10,9	11,4°	10,0	(11,6)	x	11,4	23,5°	9,6	(12,1)	x	12,3	37,0°
0,5 x	60,0	16,1	(16,1)	x	16,1	0°	15,5	(16,7)	x	16,5	7,6°	14,9	(17,5)	x	17,9	16,2°	14,3	(18,4)	x	20,7	26,7°
0,33 x	92,0	24,3	(24,3)	x	24,3	0°	23,4	(25,3)	x	25,1	5,1°	22,5	(26,5)	x	27,8	10,8°	21,4	(28,1)	x	33,3	18,3°
0,2 x	136,0	40,1	(40,1)	x	40,1	0°	38,6	(41,6)	x	42,1	3,1°	37,0	(43,6)	x	46,2	6,6°	35,1	(46,6)	x	56,8	11,4°
0,1 x	275,0	79,5	(79,5)	x	79,5	0°	76,6	(82,6)	x	82,4	1,6°	73,5	(86,6)	x	92,3	3,4°	69,6	(92,6)	x	114,2	5,8°



WWW.STEMMER-IMAGING.COM · IMAGING IS OUR PASSION

GERMANY
AUSTRIA
Phone: +49 89 80902-0
info@stemmer-imaging.de

UNITED KINGDOM
IRELAND
Phone: +44 1252 780000
info@stemmer-imaging.co.uk

FRANCE
Phone: +33 1 45069560
info@stemmer-imaging.fr

SWITZERLAND
LIECHTENSTEIN
Phone: +41 55 415 90 90
info@stemmer-imaging.ch

THE NETHERLANDS
BELGIUM · LUXEMBOURG
Phone: +31 575 495159
info@stemmer-imaging.nl

